



Dependable Products From People You Trust



Ultrasonic Cement Analyzer

Single Cell: #120-50

Dual Cell: #120-52

Instruction Manual

Updated 1/31/2025

Ver. 9

OFI Testing Equipment, Inc.

11302 Steeplecrest Dr. · Houston, Texas · 77065 · U.S.A.

Tele: 832.320.7300 · Fax: 713.880.9886 · www.ofite.com

Table of Contents

Introduction	2
Description	2
Features	2
Specifications	3
Components	3
Safety	5
Setup	6
<i>Hardware</i>	6
<i>Software</i>	7
Software	9
Operation	13
<i>Temperature Profile</i>	13
<i>Cell Cap Assembly</i>	15
<i>Preparing the Test Cell</i>	17
<i>Connecting the Cell</i>	19
<i>Performing the Test</i>	20
<i>Removing the Test Cell</i>	23
Maintenance	24
<i>Cleaning the Test Cell</i>	24
<i>Changing a Fuse</i>	25
Appendix	27
<i>Calibration</i>	27
<i>Calibration Archive</i>	28
<i>Multiple Instruments</i>	29
<i>Serial to USB Converter</i>	30
<i>Manual Temperature Control</i>	32
<i>Electrical System Grounding</i>	35
<i>Troubleshooting</i>	36
<i>Photos</i>	40
<i>Cell Diagram</i>	42
Warranty and Return Policy	43

Introduction

By measuring the change in velocity of an acoustic signal, the Ultrasonic Cement Analyzer provides a continuous non-destructive method of determining compressive strength as a function of time.

Description

The cement slurry to be tested is placed in heating jacket with temperature and pressure adjusted to simulate downhole conditions. An acoustic signal is then transmitted through the cement sample. As the strength of the cement increases over time, the acoustic signal travels faster through the sample.

A computer running customized Windows® software measures the transit times of the signal over time and interpolates the compressive strength values. This data is available in real time on-screen and is also stored in an Excel® spreadsheet for easy graphical viewing and printing.

Features

- Single cell and dual cell models available
- Cement samples are not destroyed
- Programmable temperature control (up to 400°F or 204.4°C)
- Maximum Pressure: 20,000 PSI (137.9 MPa)
- Self-venting regulators provide extensive pressure control
- Data is available instantly on-screen and is automatically converted to Excel® spreadsheet format.

Specifications

Size:

- Single Cell: 15" × 24" × 18" (38 × 61 × 45.8 cm)
- Dual Cell: 15" × 48" × 18" (38 × 122 × 45.8 cm)

Weight:

- Single Cell: 85 lb (39 kg)
- Dual Cell: 170 lb (78 kg)

Requirements:

- Air Supply: 100 PSI (690 kPa) Recommended, 150 PSI (1,035 kPa) Maximum, ¼" NPT Connector
- Water Supply: 40–100 PSI, 40°–100°F, ¼" NPT Connector
- Water Drain: ¼" NPT Connector
- Coolant Supply: ¼" NPT Connector
- Coolant Drain ¼" NPT Connector
- Power Supply:
 - Single Cell UCA (#120-50): 230–240 Volt, 50–60 Hz, 10 Amp, Fuse: T 10A L 250V
 - Dual Cell UCA (#120-52): 230–240 Volt, 50–60 Hz, 10 Amp, Fuse: T 10A L 250V

Computer:

- Windows XP or higher
- RS-232 Serial Port (or Serial to USB Adapter)
- Minimum Screen Resolution: 1280 × 680

Environmental Conditions:

- For indoor use only
- Maximum Altitude: 6,562 ft (2,000 m)
- Temperature: 41° - 104°F (5° - 40°C)
- Maximum Relative Humidity: 80% for temperatures up to 88°F (31°C) decreasing linearly to 50% at 104°F (40°C)

Components

Only use replacement parts that have been supplied by OFITE.

#120-50-TR	Transducer, Set of 2
#120-50-018	Fill Gauge
#120-50-021	Cell Assembly
#120-50-021A	Cell Body
#120-50-021B	Cell Cap, Bottom
#120-50-021C	Cell Cap, Top
#120-51-4	Handle for Cell Cap
#120-50-027-1	Seal Ring
#123-011	O-ring
#120-50-026	Retaining Ring
#120-50-039	Box-End Wrench, ½"
#120-50-040	Box-End Wrench, ⅝"
#120-50-041	Strap Wrench, 18"
#120-50-047	Spring for Transducer
#120-50-053	Heater
#120-50-064	Set of Transducer Cables for #120-52
#120-50-077	Set of Transducer Cables for #120-50

#120-51-031 Adjustable Wrench for UCA Test Cell
 #120-90-033 Air Filter
 #120-209 Thermocouple Assembly
 #122-053 Rupture Disk, 22,500 PSI
 #122-073 Fuse, Heater, 2-Amp, 5 mm × 20 mm, Qty: 6
 #122-075-2 Fuse, Pump and Cooling Solenoid, 6-Amp, 5 mm × 20 mm,
 Qty: 3
 #122-077 Fuse, Main Power, 10-Amp, 5 mm × 20 mm, Qty: 6
 #123-024-1 Acoustic Couplant (0° - 600°F), 12 oz
 #130-75-27 Allen Key, T-handle, 3/16"

Optional:







#120-50-SP Spare Parts for Single Cell UCA

#120-209 Thermocouple, Type J, Qty: 1
 #120-210 Thermocouple, Type J, Qty: 1
 #120-50-027-1 Seal Ring, Qty: 1
 #120-50-053 Heater, Qty: 1
 #120-50-071-1 Filter, Qty: 3
 #120-50-90-1 Top Cable to Cell, Qty: 1
 #120-50-TR Transducer, Set of 2, Qty: 1
 #122-053 Rupture Disk, Qty: 1
 #122-073 Fuse, 2 Amp, 5 mm × 20 mm, Qty: 4
 #122-075-2 Fuse, 6 Amp, 5 mm × 20 mm, Qty: 2
 #122-077 Fuse, 10 Amp, 5 mm × 20 mm, Qty: 4
 #123-011 O-ring for Test Cell, Qty: 40

#120-52-SP Spare Parts for Dual Cell UCA:

#120-209 Thermocouple, Type J, Qty: 2
 #120-210 Thermocouple, Type J, Qty: 2
 #120-50-027-1 Seal Ring, Qty: 2
 #120-50-053 Heater, Qty: 2
 #120-50-071-1 Filter, Qty: 6
 #120-50-TR Transducer, Set of 2, Qty: 1
 #120-52-90-1 Top Cable to Cell, Qty: 1
 #122-053 Rupture Disk, Qty: 1
 #122-073 Fuse, 2 Amp, 5 mm × 20 mm, Qty: 8
 #122-075-2 Fuse, 6 Amp, 5 mm × 20 mm, Qty: 4
 #122-077 Fuse, 10 Amp, 5 mm × 20 mm, Qty: 8
 #123-011 O-ring for Test Cell, Qty: 80

Safety

Explanation of Symbols	
	Caution: Risk of Danger - This symbol directs the operator to consult the instruction manual for safety related warnings. (ISO-7000-0434) Whenever this symbol is used on the equipment, the user must consult the manual to determine the nature of the hazard and any actions which have to be taken.
	Hot: This symbol indicates that a surface may be hot to the touch.
	Shock Hazard: This symbol indicates a risk of electrical shock.
 Note	Note: This symbol will indicate important notes and helpful hints for the operation of the equipment.
 Tip	Tip: This symbol is used to identify operational information and best practices to obtain the most reliable data.
	Caution: Note - This symbol is used to indicate statements in the manual which warn against actions which may cause damage to the equipment during routine service or maintenance.

Setup

Hardware



1. Carefully remove the instrument from the crate and place it on a flat, stable surface. Make sure to allow for adequate air flow around the unit, especially near the vents on the sides.

To ensure personal safety, always use proper lifting techniques.

2. Make sure all switches are off and all pressure knobs are turned completely counterclockwise.
3. Connect the “Air Supply”, “Water Supply”, “Drain”, “Coolant Supply”, and “Coolant Drain” connectors on the back of the unit to their appropriate source and plug in the power cords.

Make sure the “Coolant Drain” is suitable for high temperature discharge.

4. Turn the “Main Power” switch on.
5. Connect the equipment to the computer. The optional Static Gel Strength Measurement Device requires a different set of connections to the computer.

- **Single UCA or Dual UCA** - Connect the UCA to a PC with the supplied serial cable. For computers without a serial port, a serial to USB converter is available (#130-79-19). See page 30 for more information.
- **Single SGSM or UCA and SGSM** - Connect the PC and the UCA unit to the SGSM Data Hub with the supplied serial cables. Connect the SGSM to the Data Hub with the supplied LPT cable.

When using only one SGSM on a dual cell instrument, always connect the SGSM to Cell 2.

- **Dual SGSM** - Each SGSM has a Data Hub. Connect each SGSM to its Data Hub using the supplied LPT cables. Connect the first Data Hub to the UCA unit using a serial cable. Connect both Data Hubs to the computer with serial cables.

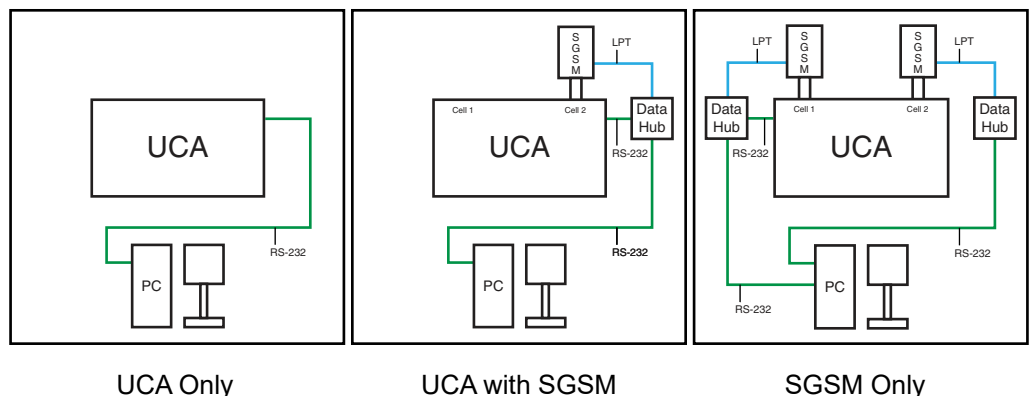

UCA Only

UCA with SGSM

SGSM Only

Setup Software

Before you begin your test, you must prepare the PC to record the data. Two software applications have been included with your instrument:

- **Single UCA** - For running a Single Cell UCA (#120-50)
 - **Dual UCA** - For running a Dual Cell UCA (#120-52)
1. Turn on the PC and UCA.
 2. Open the software by double-clicking the icon on the desktop.
 3. Click Utilities → Setup.

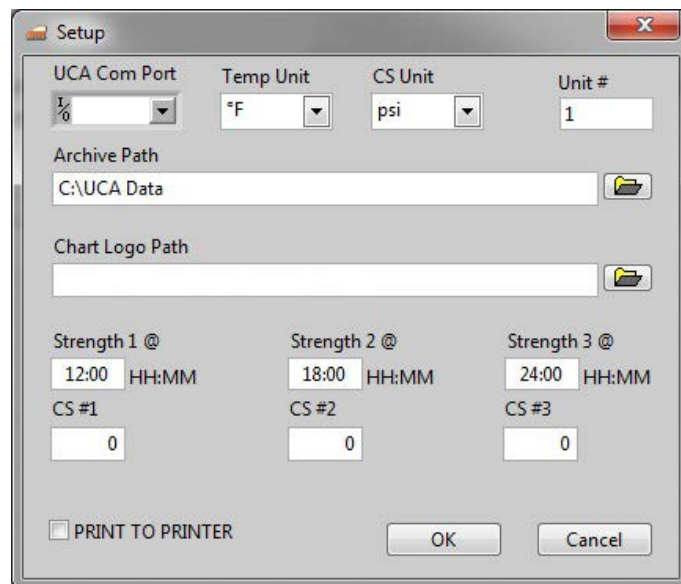

“**COM Port**” - The COM port the device is connected to. The Dual SGSM software will ask for two COM ports.

“**Temp Unit**” - °F or °C

“**CS Unit**” - PSI or MPa

“**Unit #**” - Identifies the unit generating the graph. This field is helpful when multiple units are generating graphs.

“**Archive Path**” - The location to save the data files

“**Logo Path**” - Select a logo (.JPG format) to print on the graph at the end of the test.

“Strength @”, “Strength 2 @”, “Strength 3 @” - Enter a time period in each of these three fields. At the end of the test, the compressive strength at these three times will print on the graph.

“CS #1”, “CS #2”, “CS #3” - Enter a compressive strength value in each of these fields. When the cement reaches that compressive strength, the software will record the elapsed time and print it on the graph.

“Print to Printer” - When this option is on, a graph of the test results will automatically print to the printer when a test is complete.

Software

Each software application has a set of tabs that are specific to the test configuration (Single UCA or Dual UCA).

The **UCA Info** tab shows the current UCA test configuration and a graph of the temperature profile.

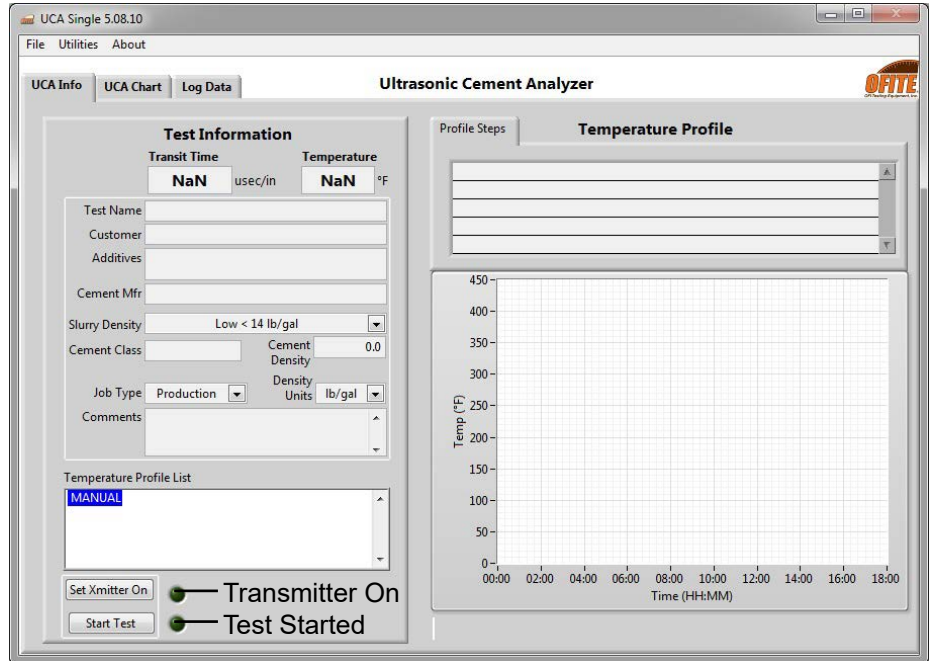

Single Cell UCA

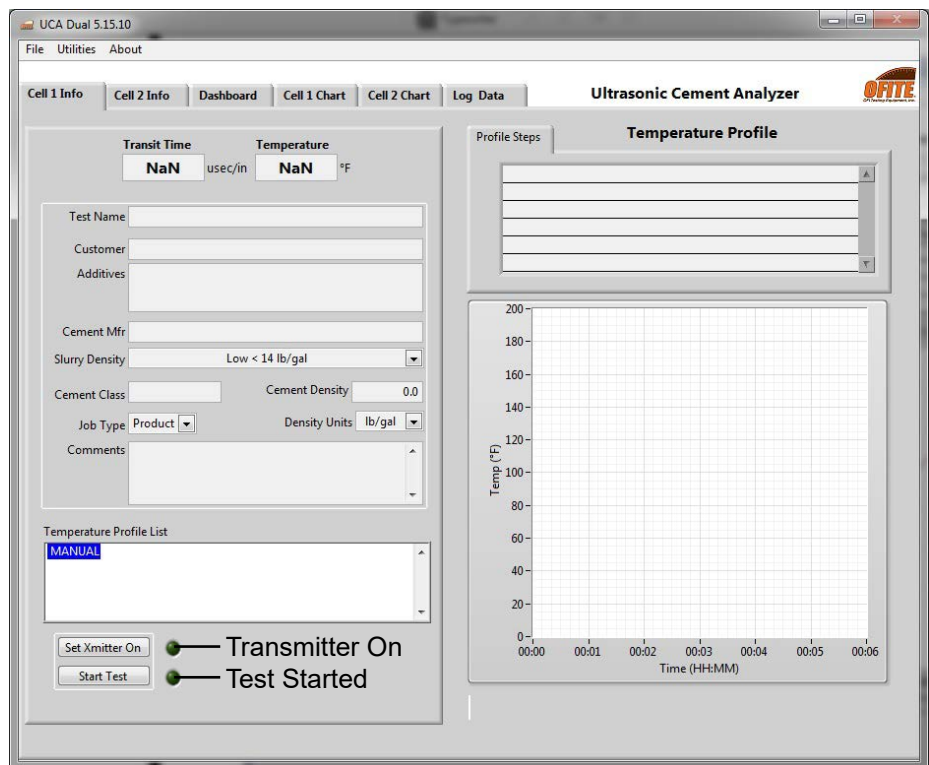

Dual Cell UCA

The **UCA Chart** shows a graph for a UCA test while the test is running.

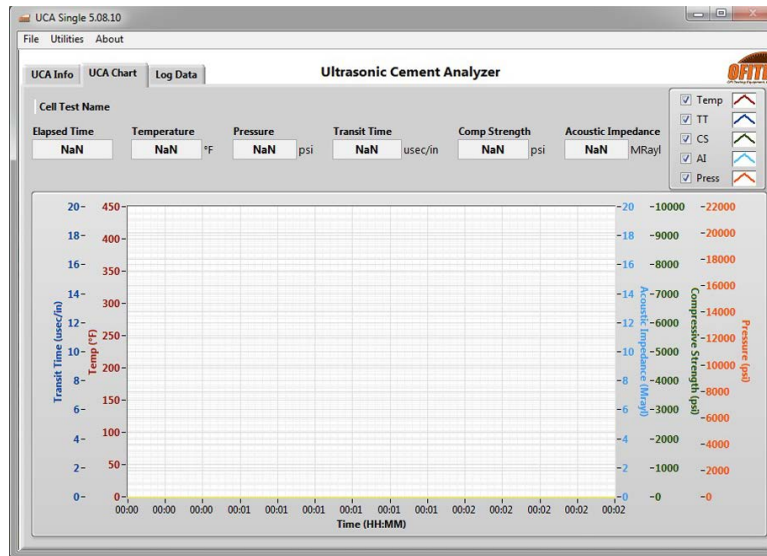

“Elapsed Time” - Time since the test began (HR:MIN:SS)

“Temperature” - Temperature within the test cell. (°F or °C, depending on the settings in the Setup screen)

“Pressure” - Pressure within the test cell. (PSI or MPa)

“Transit Time” - Time required for the sound wave to travel through the sample (Microseconds)

“Compressive Strength” - Calculated compressive strength of the sample (PSI or MPa, depending on the settings in the Setup screen)

“Acoustic Impedance” - Calculated acoustic impedance of the sample. Mostly used for well logging.

All charts in the UCA software can be manually scaled to show more or less detail. To manually scale a chart:

1. Right-click on the X or Y axis and uncheck “AutoScale X” or “AutoScale Y”.
2. Double-click the minimum value on the axis. Type in a new value.
3. Double-click the maximum value on the axis. Type in a new value.
4. The chart will now only display values between the new minimum and maximum.

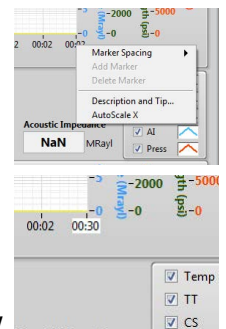

The **UCA Chart** includes an adjustable cursor feature that can be shown by right clicking on the graph and selecting Visible Items → Cursor Legend.

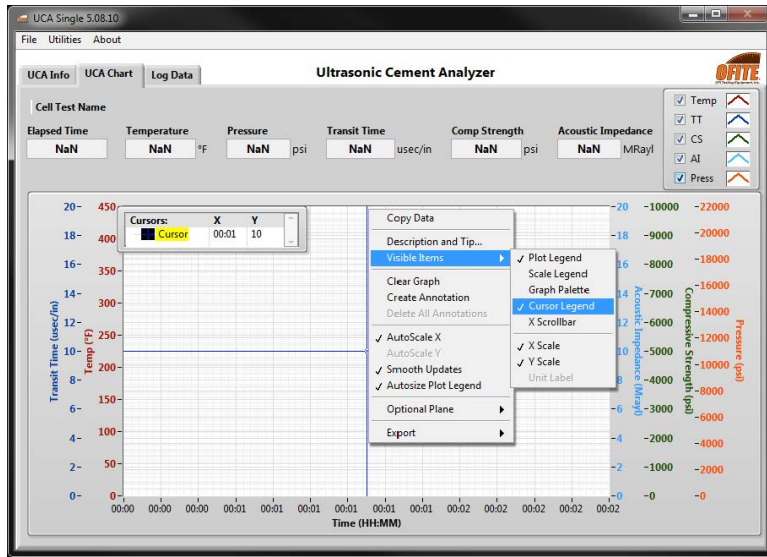

Right-click on a cursor line in the cursor legend and select “Bring to Center” to make the cursor visible. By default, the cursor names are Cursor 0, Cursor 1, Cursor 2, etc. The name of a cursor line can be edited by highlighting the name in the cursor legend and typing the desired name in the field. The X and Y values can be specified by typing in the desired coordinates on the cursor line.

By default, the cursor is yellow. The attributes of the cursor(s) can be edited to change the color, style, or line width.

The color, cursor style, point style, line style, and line width can be edited from the attributes section. To edit the cursor attributes, right-click a cursor line in the cursor legend and select “Attributes”. The name of each cursor can be displayed by checking “Show Name”.

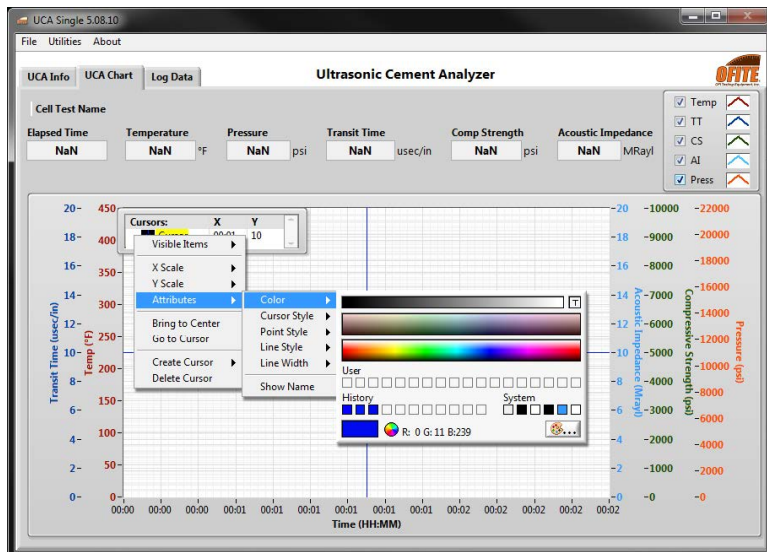

The **Dashboard** shows graphs for both cells along with current test data. Dual cell units only.

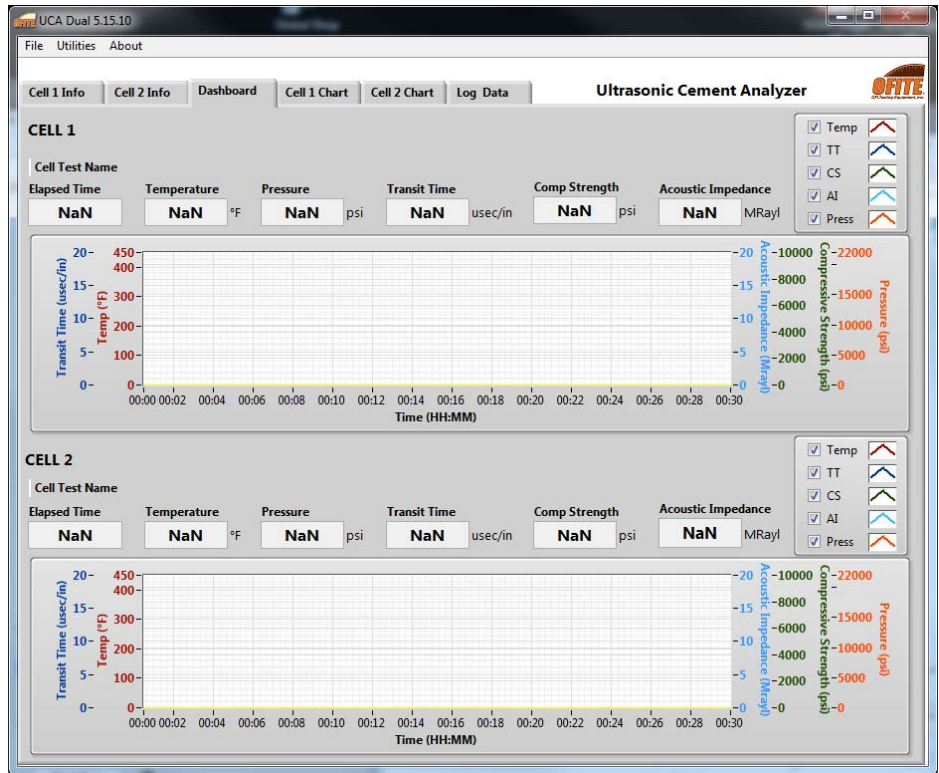

The **Log Data** tab shows the raw test data.

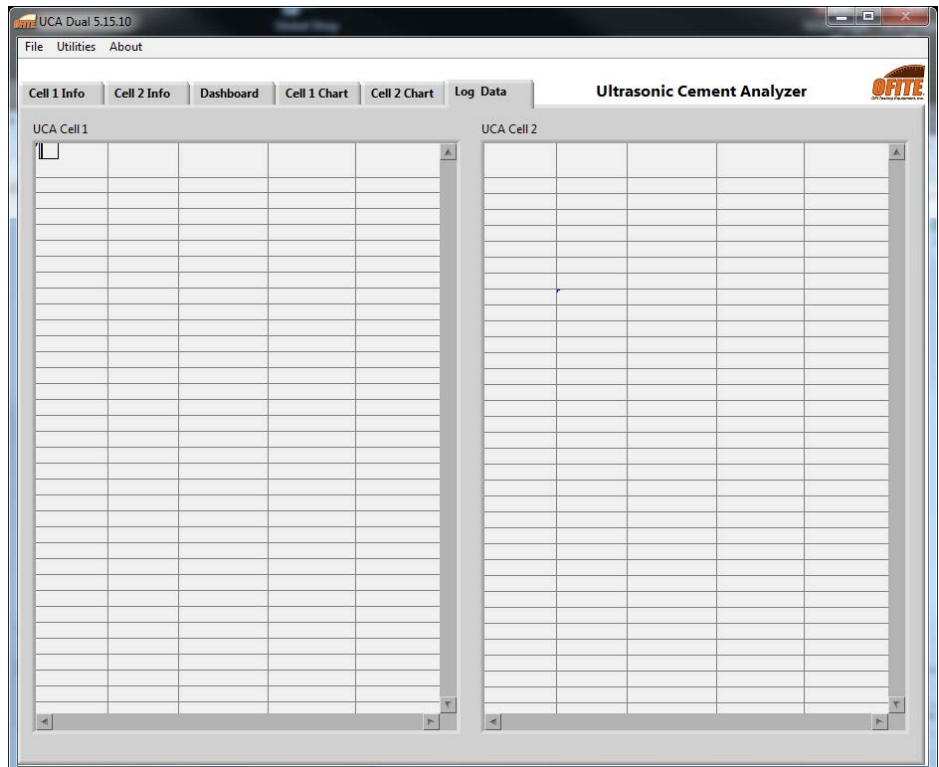

Operation

Temperature Profile

The UCA Software includes a Temperature Profile Builder. Here you can create a custom temperature profile for your test.

If you prefer to build a temperature profile manually using the Eurotherm controls, select “MANUAL” from the “Temperature Profile List” on the Cell Info tab and refer to page 32 for instructions on programming the Eurotherm.

1. Select “Temp Profile Builder” from the “Utilities” menu.
2. Either select a test to edit from the list on the left-hand side of the screen, or click “New Test” to build a new test.
3. Enter a test name.
4. Click the “Add” button to add a step. As you add steps, the graph below will change to reflect the new profile. There are three Step Types:
 - a. **Hold** - This will hold the current temperature for a set number of minutes. You will be prompted for the hold time.
 - b. **Ramp** - This will increase the temperature up to the target in a set number of minutes. You will be prompted for the ramp time and target temperature.
 - c. **Step** - This will increase the temperature up to the target as fast as possible. You will be prompted for the target temperature.
5. Click the “OK” button to add the step.
6. Make sure the “Hold Indefinitely” option is checked. With this option turned on, the test will run until you click the “End Test” button. If this option is not checked, the test will end when all the steps in the Temperature Profile are complete.

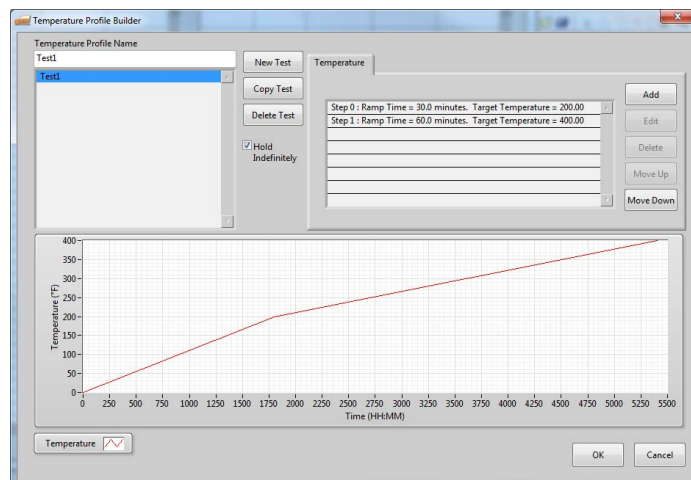

7. Click the “OK” button to exit the Temperature Profile Builder. The new Temperature Profile will now appear in the “Temperature Profile List” on the UCA information tab.
8. Once the temperature profile is built, select Operate → Load Cell Info. Here you can enter all the necessary test information in advance, before preparing the cement sample.

Most of these fields are optional. The information in them will display in the data file at the end of the test.

The following fields are required:

Test Name - Each test must have a unique test name. The software uses this field to name the data file.

Slurry Density - The software uses this field to calculate the correct compressive strength.

Cement Density - The software uses this field to calculate the acoustic impedance.

Job Type - This field is to specify what type of test is being logged.

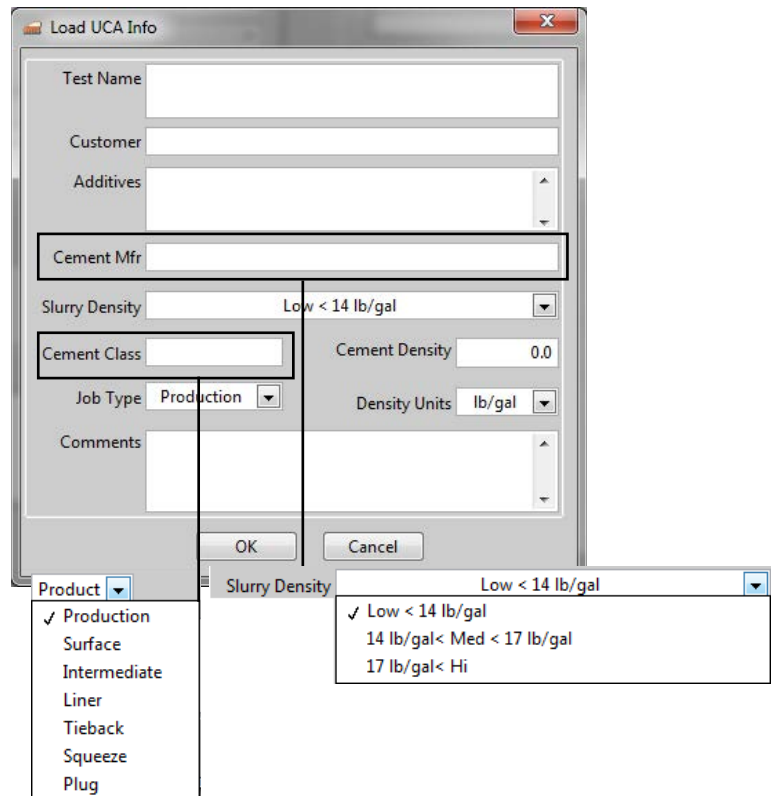

Operation

Cell Cap Assembly

1. Apply a thin layer of high-temperature grease to the inside surfaces of the two cell caps. Wipe off any excess grease.

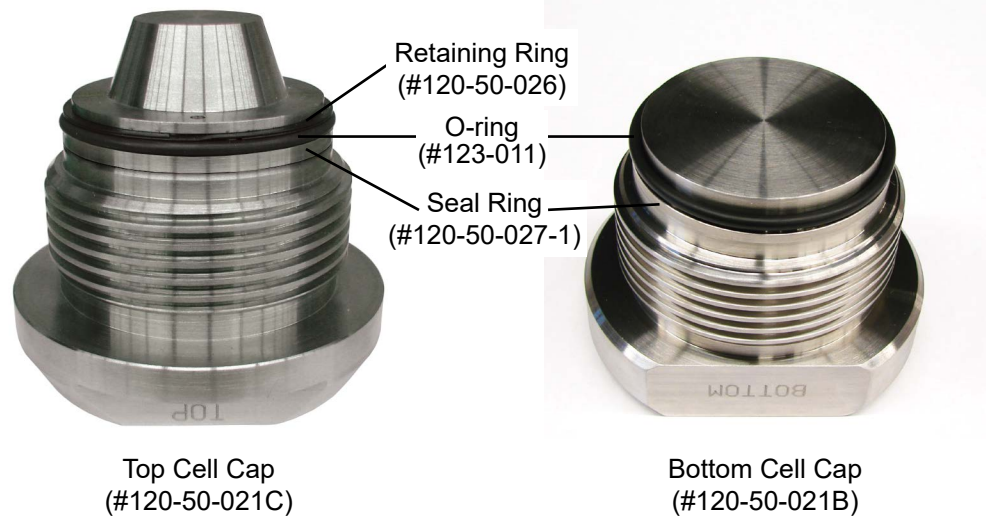

2. Apply high-temperature grease to both cell cap o-rings.
3. Place a metal seal ring onto the bottom cell cap with an o-ring on top of it. The narrow side of the metal seal ring should point towards the threads (see diagram of cross-section).
4. Place an o-ring on the top cell cap above the metal seal ring and install the retaining ring.

The retaining ring and metal seal ring should not need to be removed from the top cell cap. However, they are, make sure the metal seal ring is reinstalled in the same orientation. The narrow end should point toward the threads.



Metal Seal Ring (Cross Section)

5. Make sure the transducers and the transducer holes in the cell caps are clean and free of debris. They can be cleaned with a rag or paper towel. Alcohol can also be used if further cleaning is necessary.



Tip

6. Apply a thin coat of an ultrasonic couplant to the two transducers.

When applying the couplant, apply only the smallest amount necessary to allow for the couplant to be spread out in a very thin layer, evenly over the face of the transducer. Applying too much couplant can interfere with the integrity of the signal that is either transmitted or received by the transducers.



7. Place the top transducer into the hole in the top cell cap. Compress the spring and place the spring holder over it. Tighten the screw with a $\frac{3}{16}$ " allen wrench to secure the spring holder in place.

Operation

Preparing the Test Cell

The cell body and both cell caps were manufactured and pressure tested together. All three pieces are serialized. Before assembling the test cell, make sure all three pieces have the same serial number.

For a complete diagram of the test cell, refer to page 42.

1. The test cell is labeled to indicate which end is the top and which is the bottom. Additionally, you can identify the bottom of the cell by removing both caps and examining the grooves beneath the threads. The end with the smaller groove is the bottom of the cell.



The interior of the cell has a taper with the narrow end at the top and the wide end at the bottom. A hardened cement plug can only be pushed out of the cell from the top.

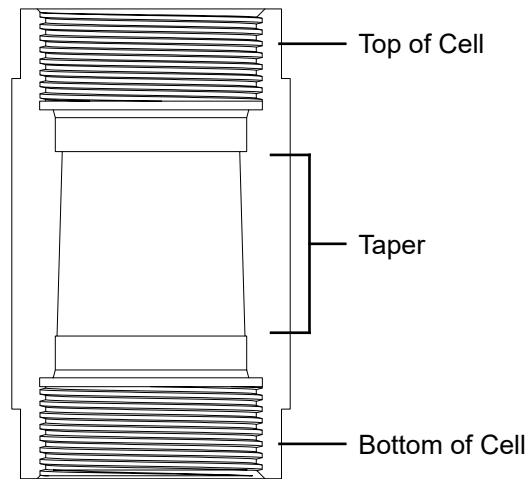

2. Apply a thin layer of high-temperature grease to any surface that will be in contact with cement. This will make cleaning easier when the test is complete.
3. Carefully screw the bottom cell cap onto the test cell.

The cell cap should turn smoothly in the test cell threads. If you encounter resistance, stop turning and unscrew the cap slightly. Then continue turning until the cap is completely tightened.

4. Once the cap is completely tightened, unscrew it one quarter turn. This will facilitate disassembly later.



5. Turn the test cell over and begin filling with the cement slurry. Place the fill gauge on top of the test cell. Fill the cell until the cement touches the bottom of the fill gauge.

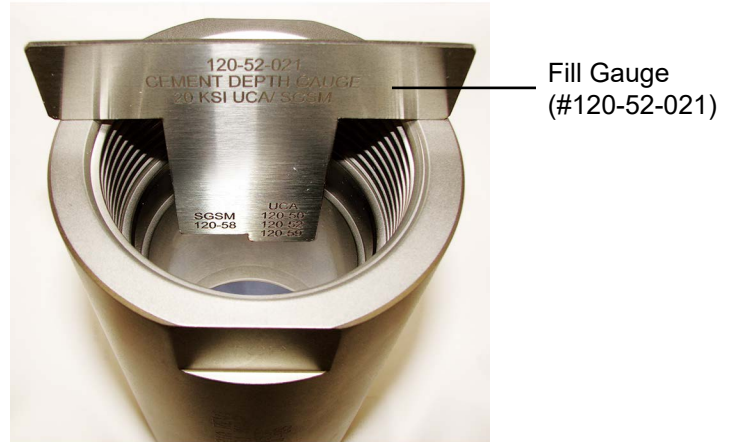

6. Carefully screw the top cell cap into the test cell, just as you did with the bottom cell cap.

Operation

Connecting the Cell

1. Carefully place the cell into the heating jacket.
2. Align the cell as shown below.
3. Screw the $\frac{1}{2}$ " connection on the high pressure supply line to the bulkhead connector. Leave the connection slightly loose for now.
4. Screw the $\frac{5}{8}$ " connection on the high pressure supply line to the port on the test cell. Use a wrench to tighten it completely.
5. Now use a $\frac{1}{2}$ " wrench to tighten the supply line to the bulkhead connector completely.
6. Screw the thermocouple into the $\frac{5}{8}$ " port on the cell cap and tighten it hand tight. Plug the thermocouple into the port on the unit cabinet.
7. Plug the transducer into the port on the unit cabinet.

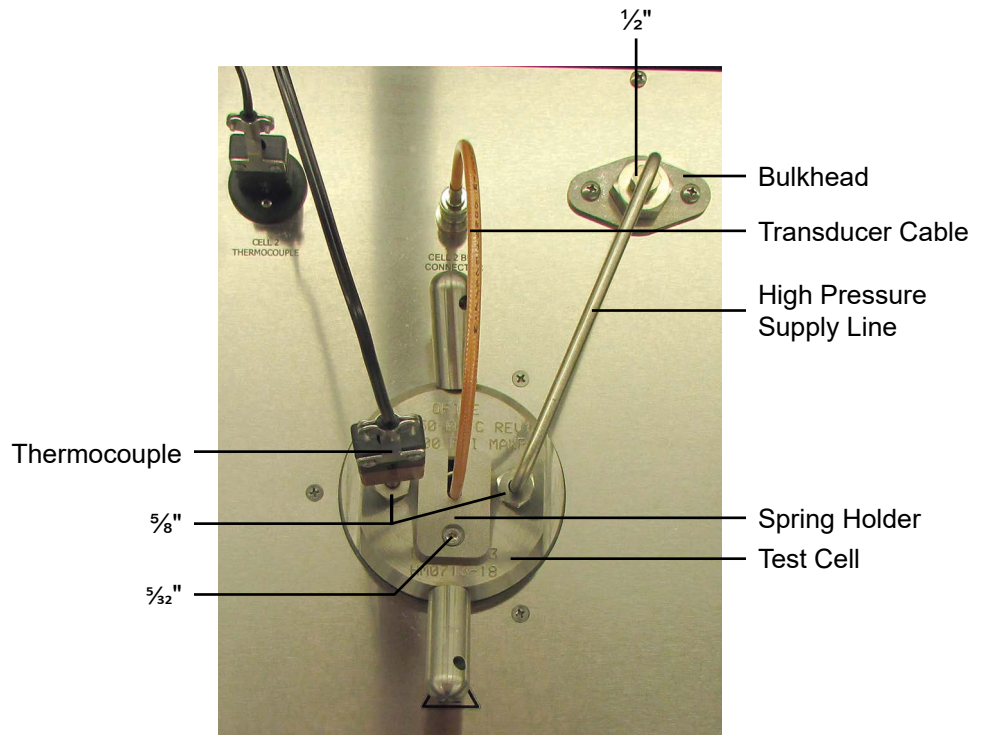

Operation

Performing the Test

Use of this equipment in a manner not specified by the manufacturer may impair the protections provided by the equipment.

1. In the software, program a temperature profile for each test (see page 13).
2. Assemble the test cell (see page 15), load it into the heating jacket and make all the necessary connections (see page 19).
3. Make sure the Cell Pressure Regulator is closed (counterclockwise), the Back Pressure Regulator is open (clockwise), and the Pressure Release valve is closed (clockwise).

Dual Cell UCA Control Panel

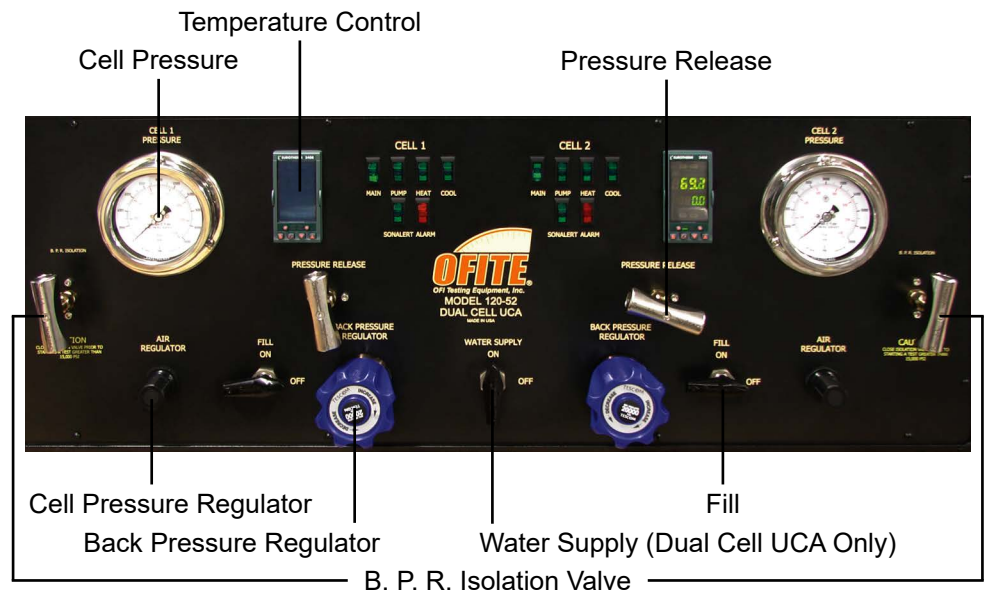

Single Cell UCA Control Panel

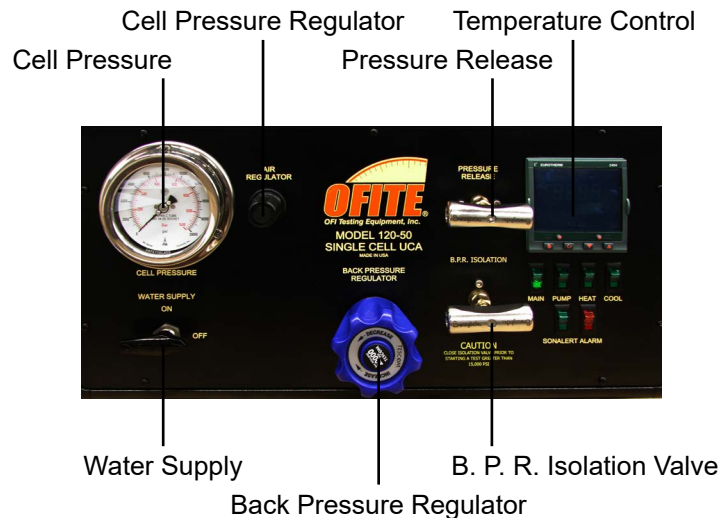

4. Turn the Water Supply valve on.
5. Slowly turn the Fill valve to On. The cell will begin filling with water.

Watch for water to leak from the thermocouple. When the water starts to leak, immediately tighten the thermocouple with a wrench to seal the cell. This will ensure that all air has been purged from the cell.

You may hear water circulating through the system. This means the Back Pressure Regulator is open too much and pressure is venting from the cell. Close the Back Pressure Regulator slightly by turning it clockwise. The sound will stop and enough pressure will build in the cell to purge the air.

6. Turn the “Main Power” and “Pump” switches on.
7. Turn the regulator clockwise to increase the pressure within the test cell. If the pump is pumping but the pressure does not build, the back pressure regulator is not set properly. Turn the back pressure regulator clockwise. Allow the pressure to build slightly higher than necessary for your test. Then, turn the back pressure regulator counterclockwise slowly to lower the pressure.

The regulator allows pressure to enter the test cell. If the pressure falls too low, the pump engages to bring it back up. Turning the regulator clockwise increases the pump pressure. The back pressure regulator sets the pressure setpoint and vents unwanted pressure above the setpoint. If the pressure builds up too much (due to thermal expansion), the back pressure regulator bleeds off the excess. Turning the back pressure regulator counterclockwise decreases the pressure setpoint.

Correctly setting the regulator and back pressure regulator is a trial and error process. Always start with the back pressure regulator closed (clockwise) and use the regulator to increase the pressure higher than you need. Then, slowly open the back pressure regulator (counterclockwise) until the pressure drops to the desired level.

Add pressure to the cell in 1,000 PSI increments. At each increment, wait to ensure pressure is holding. Observe the “Cell Pressure” gauge. If the pressure begins to fall, release pressure and check for leaks in the plumbing. Once set, you should not need to adjust the pressure for subsequent tests.

For tests above 15,000 PSI, close (clockwise) the B.P.R. Isolation valve before adding pressure. This will bypass the Back Pressure Regulator and allow testing at higher pressures.

With the B.P.R. Isolation valve closed, the Back Pressure Regulator will not automatically vent excess pressure. The operator must carefully monitor the pressure inside the cell during the test and use the Pressure Release valve to vent excess pressure manually.





Never adjust the B.P.R. Isolation valve when there is more than 3,000 PSI in the test cell. Doing so will damage the internal components.

8. Once the pressure is set, it is time to start the test.

Go to the “Cell Info” tab in the software. Select a temperature profile from the Temperature Profile List. If you prefer to program the Eurotherm manually, select “MANUAL” from the list. Click the “Start Test” button. The selected temperature profile will stay highlighted throughout the test.

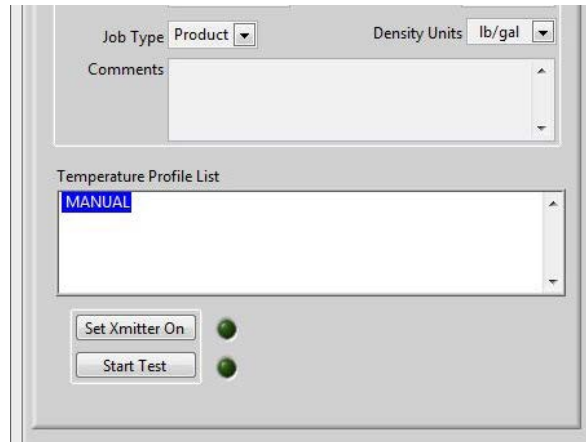

9. After clicking the “Start Test” button you have one more opportunity to enter information about the test. Refer to page 14 for more information about the entering test information.

When you click the “OK” button, the test will begin.



Solid particles and air bubbles within the cement slurry can adversely affect the results of your test. The first Transit Time reading should be at least 10 μ s. If it is less than 10 μ s:

- a. Wait a few minutes to see if the problem corrects itself.
 - b. If the transit time remains below 10 μ s, restart the test by clicking “Stop Test” and then “Start Test”.
 - c. If the problem persists, remix the slurry and start the test again. To avoid this problem, carefully follow the mixing procedure in API Specification 10.
10. Turn the “Heat” switch on.
 11. If you are running a manual temperature profile, push the “RUN/HOLD” button on the temperature controller to begin heating. Verify the “RUN/HOLD” light is on to ensure the program is running.

Operation

Removing the Test Cell



Note



1. When the test is complete, click the “End Test” button in the software. The data file will be automatically saved in the folder specified on the “Setup” screen.

If you were running a manual temperature profile, push the “Run/Hold” button on the controller and hold it until both lights are off.

2. Turn the “Heat” switch off.
3. Turn the “Cool” switch on and allow the test cell to cool completely.
4. When the cell has cooled, turn the “Pump” and “Cool” switches off.
5. Turn the “Fill” valve to “OFF”.
6. Open the pressure release valve by **slowly** turning it counterclockwise.

Always open the pressure release valve very slowly to prevent pulling cement into the plumbing.

7. Unscrew and remove the high-pressure line from the cell cap and the instrument cabinet.
8. Unplug the thermocouple and transducer.
9. Lift the cell out of the heating jacket.

When removing the test cell, pay special attention to the transducer and make sure it doesn't pull off of the end of the transducer cable with the cell.

Use caution. The test cell may contain a small amount of air at high temperature and / or pressure.



Top Cap Removal



Bottom Cap Removal

Maintenance

Cleaning the Test Cell

The test cell must be cleaned immediately after every test. Any cement left in the test cell will harden and could damage the equipment. Clean all surfaces of the test cell with soap and water.

Remove all o-rings and seal rings and clean them individually. Carefully inspect them and discard any that show damage or wear.

The cement in the cell will be solid. It may be necessary to press the cement block out. Follow the procedure below:

1. Remove both cell caps and pour off any excess water.



Tip

If the cell caps on the test cell will not turn, use a rubber mallet and strike the top and bottom of the test cell.

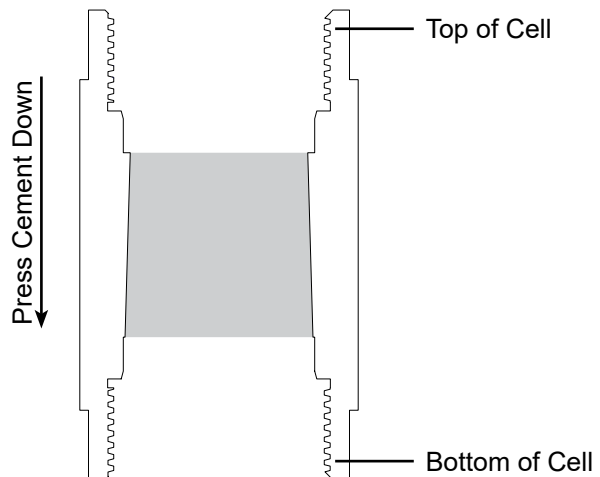

2. Remove the cement plug from the cell by pressing from the top down.
3. The test cell must be cleaned of all cement residue. Any cement left in the test cell will harden and could damage the equipment. Clean all surfaces of the test cell with soap and water.



Do not use any type of decontamination or cleaning agents as they may cause a hazard as a result of a reaction with parts of the equipment or with material contained within. If there is any doubt about the compatibility of a decontamination or cleaning agent please contact OFITE Technical Support.

Maintenance

Changing a Fuse

If one of the main systems on the UCA (main power, fan, heater, pump, and cooling solenoid) is not working, then you may need to check the fuses.

1. Removing the back panel on the UCA and inspect the terminal block which holds the fuses. They are labeled as follows:
2. If a fuse for a particular system is blown, a red LED light will come on below the blown fuse's housing.
3. Unplug the power cord leading to the UCA.
4. Depressing the tab on the bottom of the fuse housing should allow you to flip the housing up.
5. Open the door on the side of the fuse housing.
6. Replace the blown fuse.
7. Close the door on the fuse housing and push the housing down back into place.
8. Plug the power cord back into the UCA.
9. Check to ensure the system is working again.

Dual Cell UCA (#120-52)				
		System	Fuse Type	Part#
Unit 1				
Fuse 1	F1	Main Power	10 Amp	#122-077
Fuse 2	F2	Main Power	10 Amp	#122-077
Fuse 3	F3	Fan	2 Amp	#122-073
Fuse 4	F4	Heater	6 Amp	#122-075-2
Fuse 5	F5	Pump and Cooling Solenoid	2 Amp	#122-073
Unit 2				
Fuse 1	F6	Main Power	10 Amp	#122-077
Fuse 2	F7	Main Power	10 Amp	#122-077
Fuse 3	F8	Fan	2 Amp	#122-073
Fuse 4	F9	Heater	6 Amp	#122-075-2
Fuse 5	F10	Pump and Cooling Solenoid	2 Amp	#122-073

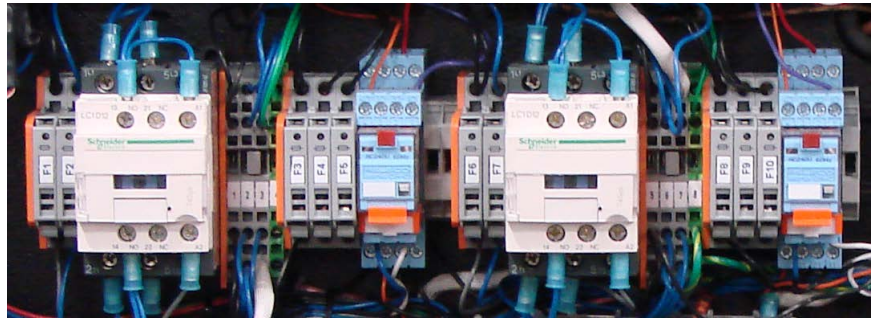

Fuses - Dual Cell UCA (#120-52)

Single Cell UCA (#120-50)				
		System	Fuse Type	Part#
Fuse 1	F1	Main Power	10 Amp	#122-077
Fuse 2	F2	Main Power	10 Amp	#122-077
Fuse 3	F3	Fan	2 Amp	#122-073
Fuse 4	F4	Heater	6 Amp	#122-075-2
Fuse 5	F5	Pump and Cooling Solenoid	2 Amp	#122-073

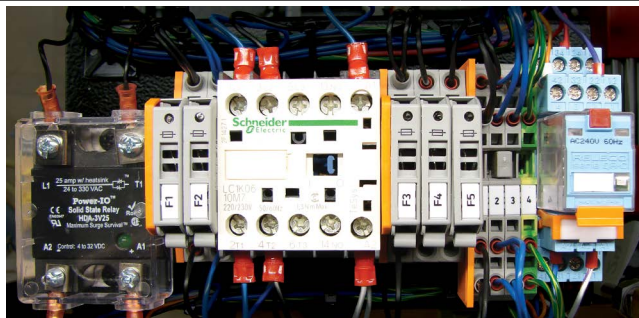

Fuses - Single Cell UCA (#120-50)

Appendix

Calibration



Note

The UCA unit should be calibrated initially upon install. It should then be calibrated whenever any part of the test cell, transducers, control card or software are changed.

1. Begin by filling the test cell with distilled water and placing it in the unit as described in the “Preparing the Test Cell” section on page 17.
2. Wait for the sample temperature to reach $70^{\circ} \pm 2^{\circ}\text{F}$ ($21.1^{\circ} \pm 1.1^{\circ}\text{C}$).

If the sample temperature is outside this range, transit time may be different than expected.

3. Click the “Set Xmitter On” button on the “UCA Info” tab in the software. Wait 10 seconds.
4. Click Utilities → Calibrate UCA.
5. The transit time should be 17.5–19 μsec (at $70^{\circ} \pm 2^{\circ}\text{F}$). The “New Cal Offset” should be less than $\pm 1.5 \mu\text{sec}$. The “Signal Strength” should be at 1. If all conditions passed, click “OK” to save the calibration and continue.

If the transit time is not within this range, it could be an indication that the transducers are failing or the transducer cables are damaged. Inspect and clean the transducers as well as the transducer cables and connections. Check the transducer springs for weakening or wear. If the transit time is still out of range, then you may need to get replacement parts for the transducers, cables, or springs.

If you notice signal strength declining over time, this is an indication that the transducers are wearing out and should be replaced. A weak signal may have an adverse effect on test results.

If the software displays an error message, contact OFITE for support.

6. Click the “Set Xmitter Off” button to turn off the transmitter.

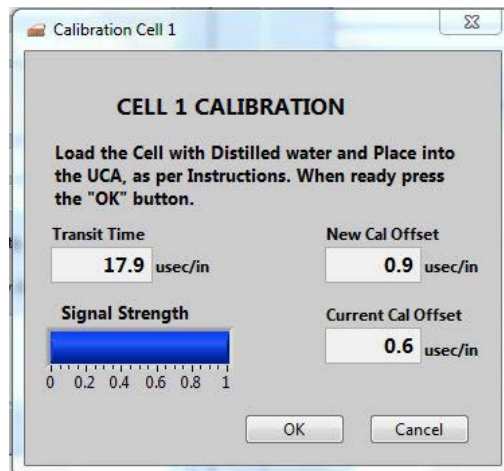

Appendix Calibration Archive

The UCA software stores all calibration data from prior calibrations. To view data from a previous calibration, select “Calibration Archive” from the “Utilities” menu. A list of previous calibrations will appear in a window to the left. Click on a calibration record and export to view the data.

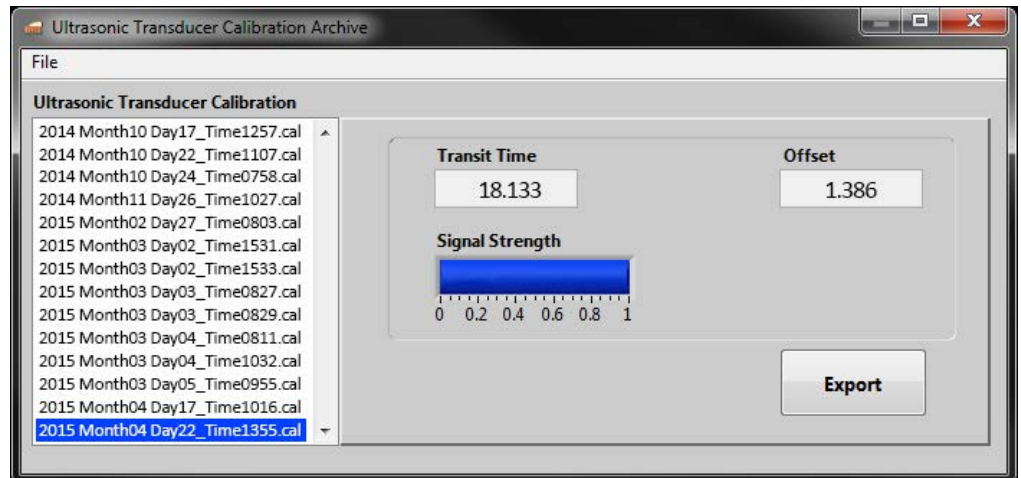

A final prompt will appear to indicate when the file has exported successfully.

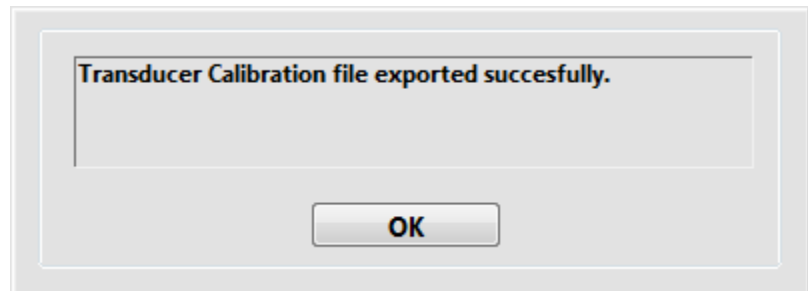

Appendix

Multiple Instruments

It is possible to control multiple UCAs from a single computer. To setup the software for multiple UCAs, repeat the following procedure for each instrument.

1. Plug each instrument into a separate serial port on the computer.
2. On the computer, navigate to the “C:\Program Files (x86)” folder.
3. Locate the “UCA” folder and select it.
4. Hold down the CTRL key and then hit C. Then hold down the CTRL key and hit V. This will create a duplicate of the folder called “UCA - Copy”.
5. Choose a name to identify the new instrument.
6. Rename the new folder with the name of the instrument.
7. Locate the program file (.exe) inside the folder and rename it with the name of the instrument.



Tip

For convenience, create a shortcut to this file on the desktop.

8. Open the software using the new program file.
9. Change the “Archive Path” to a new folder. See page 7 for instructions.



Note

Each instrument must have its own Archive Path.

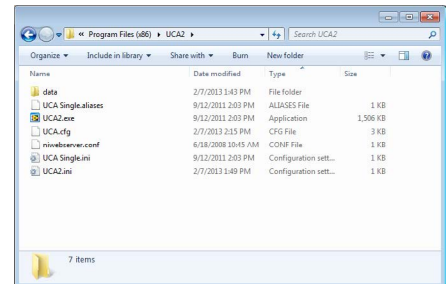
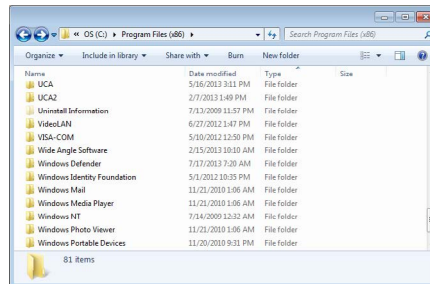

Appendix

Serial to USB Converter



Note

The UCA communicates with the PC via a serial (RS-232) port on the back. For computers without a serial port, a serial to USB converter is available (#130-79-19). However, before using the serial to USB converter with the UCA, the Latency Timer must be adjusted.

1. Connect the converter to both the UCA and the PC.

The PC will try to automatically download and install the driver. If the automatic install fails, go to <http://www.ftdichip.com/Drivers/VCP.htm> to download and install the driver manually.

2. Open Device Manager on the computer.
 - a. Click the Start Menu.
 - b. In the “Run” or “Search Programs and Files” field, type `devmgmt.msc` and press Enter.
3. Under “Ports (COM & LPT)” find the entry for “USB Serial Port”.

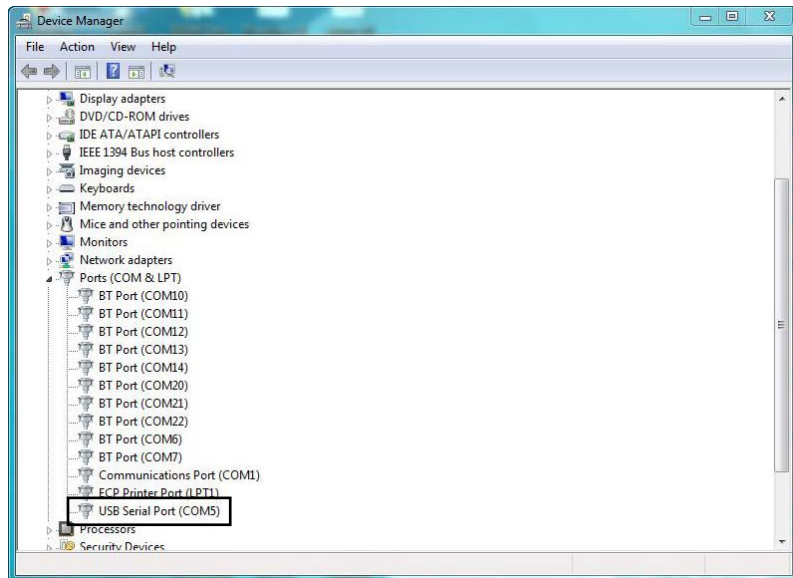

4. Right-click “USB Serial Port” and select Properties.
5. Go to the “Port Settings” tab and click the “Advanced...” button.

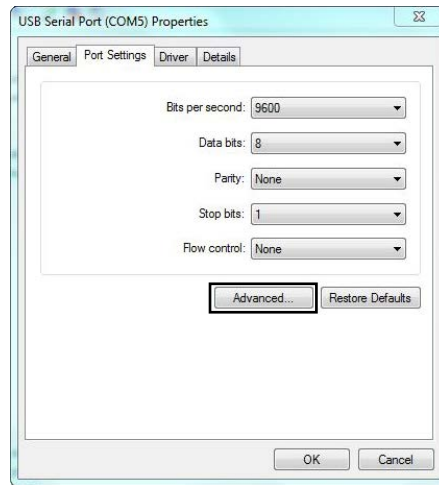

6. Change the “Latency Timer (msec)” setting from 16 to 8.

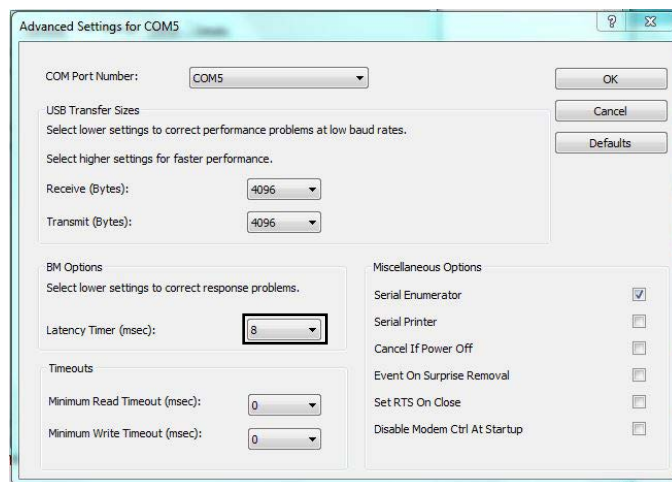

7. Click OK.

Appendix

Manual Temperature Control

The Eurotherm temperature controller allows you to program a temperature profile for your test. This profile will be divided into at least two segments. Each segment represents either a change in temperature or a period of time to hold the current temperature.

The four buttons along the bottom of the display provide access to the temperature controller parameters. To program a test:

1. Press the "PAGE" button until the display reads "Prog List".
2. Press the "SCROLL" key to select the parameter you want to change.
3. Press either arrow key to set the value for the parameter.
4. Repeat steps 2 and 3 until all parameters are set.



The P.I.D. and other internal settings have been optimized for this instrument. Do not change anything other than program parameters.

For more information, refer to the Eurotherm instruction manual.

The first group of parameters will be the same for every test. Do not change them:

<u>Parameter</u>	<u>Value</u>
Prg1	1
Hb	OFF
Hb.u	0.0
Rmp.u	min
Dwl.u	min
Cyc.n	1

Temperature Controller

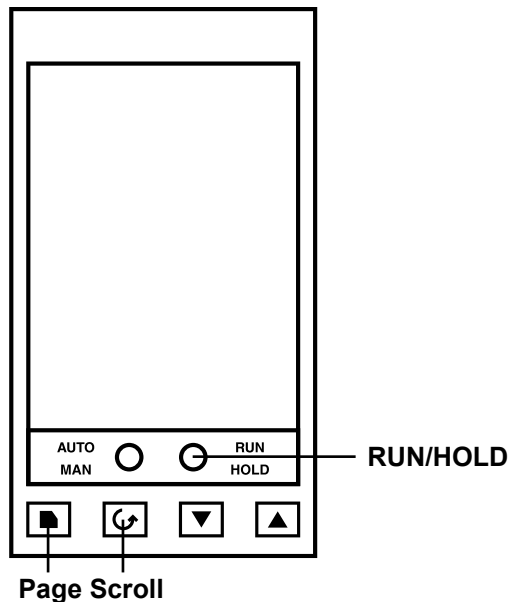

1. Begin by defining the first segment of the test.
 - a. Press the “SCROLL” key until “Seg” appears on the display.
 - b. Press either arrow key to select “1” (segment 1).
2. The first parameter is “Type”.
 - a. Press the “SCROLL” key to select “Type”.
 - b. The available options are “rmp.r”, “rmp.t”, or “dwell”. Press either arrow key to select one.

Rmp.r programs the controller to steadily increase the temperature by a specified rate (degrees per minute). If you choose this option, the next parameter will be “Tgt” (target temperature) and then “Rate” (degrees per minute).

Rmp.t increases the temperature over a specified time interval (minutes). If you choose this option, the next parameter will be “Tgt” (target temperature) and then “Dur” (duration in minutes).

Dwell holds the temperature at its current set point for a specified length of time. If you choose this option, the next parameter will be “Dur” (duration in minutes).

- c. Press the “SCROLL” key to select the remaining parameters (target temperature, rate, or duration).
 - d. Press either arrow key to select the options for each parameter.
3. Now define the second segment.
 - a. Press the “SCROLL” key until “Seg” appears on the display.
 - b. Press either arrow key to select “2” (segment 2).
4. Continue this process with each segment in the test.
5. When you reach the last segment, set the “Type” to “end”. The next parameter will be “End.t”.

If you choose “**sop**”, the heat will be turned off and the test ended.

If you choose “**dwell**”, the heat will be held at the current temperature indefinitely.

Example 1:

Heat the sample at 2.5° per minute and stop at 150°. Hold at 150° for 180 minutes and then stop the heat.

<u>Parameter</u>	<u>Value</u>	<u>Description</u>
Prg	1	} Do not change
Hb	OFF	
Hb.u	0.0	
Rmp.u	min	
Dwl.u	min	
Cyc.n	1	
Seg	1	Segment 1
Type	rmp.r	Increase temperature at a specified rate
Tgt	150	Heat to 150°
Rate	2.5	Increase temperature at 2.5° per minute
Seg	2	Segment 2
Type	dwll	Hold on the current temperature
Dur	180	Hold for 180 minutes
Seg	3	Segment 3
Type	end	This is the last segment
End.t	sop	Stop the heat

Example 2:

Heat the sample to 200° over a period of 90 minutes. Then increase the temperature to 300° at a rate of 3° per minute. Hold that temperature until the unit is turned off.

Prg	1	} Do not change
Hb	OFF	
Hb.u	0.0	
Rmp.u	min	
Dwl.u	min	
Cyc.n	1	
Seg	1	Segment 1
Type	rmp.t	Increase temperature for a specified time
Tgt	200	Heat to 200°
Dur	90	Increase temperature for 90 minutes
Seg	2	Segment 2
Type	rmp.r	Increase temperature at a specified rate
Tgt	300	Heat to 300°
Rate	3	Increase temperature at 3° per minute
Seg	3	Segment 3
Type	end	This is the last segment
End.t	dwll	Hold at the current temperature indefinitely

Appendix

Electrical System Grounding

Proper grounding protects the equipment operator from the risk of electric shock. The electrical cord provided with this equipment has an equipment grounding conductor and a grounding plug. Observe the following guidelines at all times:

- Always connect the plug to a matching outlet that is properly installed and grounded.
- If an extension cord is necessary, make sure it has three prongs and is compatible with the electrical cord provided with the equipment.
- Do not modify the electrical cord provided with the equipment. If it is not compatible with any available outlets, have a compatible outlet installed by a qualified electrician.
- If the equipment-grounding conductor (solid green or green and yellow) is improperly connected, the operator will be at risk of electrical shock. Never connect it to a live terminal.
- Local codes may require a Ground Fault Circuit Interrupter (GFCI).
- Repair or replace a damaged or worn cord immediately.
- When in doubt, consult a qualified electrician.

Appendix

Troubleshooting

Symptom	Cause	Remedy
Power		
There is no power to the machine	The main power cord is not plugged in.	Ensure the power cord(s) is firmly into the wall and the machine
	One of the fuses for the main power supply is blown	Check and replace the fuses, see page 25
Heating / Cooling		
The unit is not heating	The heater switch is not on	Turn the heater switch to the on position
	The heater fuse is blown	Replace heater fuse, see page 25
	Temperature overshoot tripped LF Controller	Turn main power off and then back on. Make sure unit is not overheating
The unit is overheating	The thermocouple is not plugged in	Plug in the thermocouple
	The temperature controller is not programmed correctly	Check the temperature ramp profile in the software or on the Eurotherm temperature controller
	The Eurotherm temperature controller is not working	Replace the temperature control
	The hold light is lit on the temp controller	Press the run/hold button until the light goes off
The unit is not able to maintain temperature or the temperature is cycling uncontrollably	The coolant water is on	Turn off the cooling water
	The thermocouple is not plugged in	Plug in the thermocouple
	The thermocouple wires have been reversed	Switch the wires on the thermocouple leads

Symptom	Cause	Remedy
Thermocouple		
Thermocouple will not fit into the cell cap	The port is filled with cement	Use a small drill bit to clear the cement blockage
	The thermocouple is bent	Replace the thermocouple
	The hub collar is too low on the thermocouple shaft	Screw the collar up until there are 2 threads showing
Pressure		
The unit will not hold pressure	There is a leak at one of the fittings	Trace the tubing and tighten the leaking connection
	The regulator (black valve) is leaking	Replace the regulator
	The back pressure regulator (blue valve) is leaking	Rebuild the regulator according to specs (rebuild kits and manuals are available) Replace the regulator
	The pressure release valve (PRV) is damaged	Replace the PRV
	The cell o-rings are worn or not seated properly	Disassemble the cell and inspect all o-rings. Discard any that show signs of damage or wear
The unit will not build pressure	There is a leak at one of the fittings	Trace the tubing and tighten the leaking connection
	The regulator (black valve) is leaking	Replace the regulator
	The back pressure regulator (blue valve) is leaking	Rebuild the regulator according to specs (rebuild kits and manuals are available) Replace the regulator
	The pump is broken (not cycling, constantly cycling)	Replace the pump

Symptom	Cause	Remedy
Pressure (Continued)		
	The Rupture Disk is blown	Replace the Rupture Disk
Software		
There is no transit time	The transducers are dirty	Clean the transducers
	Too much couplant has been applied to the transducers	Wipe off the transducers and apply a smaller amount of couplant to the transmitter surface
	The springs do not provide enough force to keep the transducer in contact with the steel surface	Replace the springs
	The transducer cables have been damaged	Replace the transducer cables
	The transducers have exceeded their useful life	Replace the transducers
Trace lines are missing from the graph	The boxes for each line are unchecked	Check the appropriate boxes
Leaks		
Water is not flowing to the cell	The filter is plugged	Clean the filter (see photo on page 40)
	The fill tubing is plugged	Check the tubing for obstruction
	The fittings and/or cell cap openings are clogged with cement	Check the openings and clean if necessary
Water is leaking from the fitting	The threads have been damaged	Replace the fitting
	The collar on the thermocouple connection is too high or too low	Adjust the collar until 2 threads are exposed
	Cement has clogged the inner surface of the port	Clean cement out of the port

Symptom	Cause	Remedy
Leaks (Continued)		
The test cell is leaking cement	The o-ring has been damaged	Replace the o-ring
	The o-ring has come out of the groove	Reseat the o-ring
	The metal seal ring is upside down	Make sure the pointed end of the metal seal ring is installed with the narrow side away from the o-ring (see diagram on page 42)
Weak or intermittent transit time signal during calibration or test	Dirty transducers or transducer cavity	Remove and clean both the transducers and transducer cavity.
	Worn transducer cables and/or BNC connections	Remove and check the cables for kinks and connections for dirty or worn area. Clean or replace as necessary.
	Excessive transducer couplant used	Clean transducers
	Degraded transducers	Replace transducers
	Couplant used is not rated for the test temperature	Remove and clean the transducers and reapply the proper couplant

Appendix

Photos

**Dual Cell UCA (#120-52)
Top View With Middle Panel Removed**

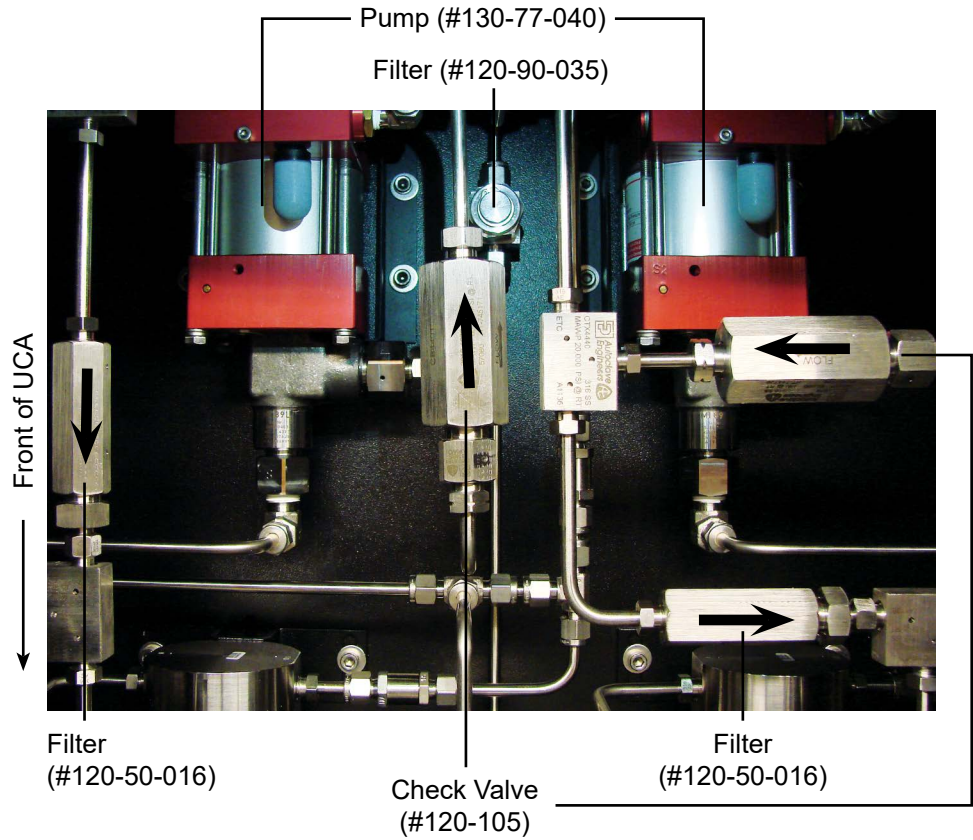

**Dual Cell UCA (#120-52)
Electronics - Black Panel Removed**

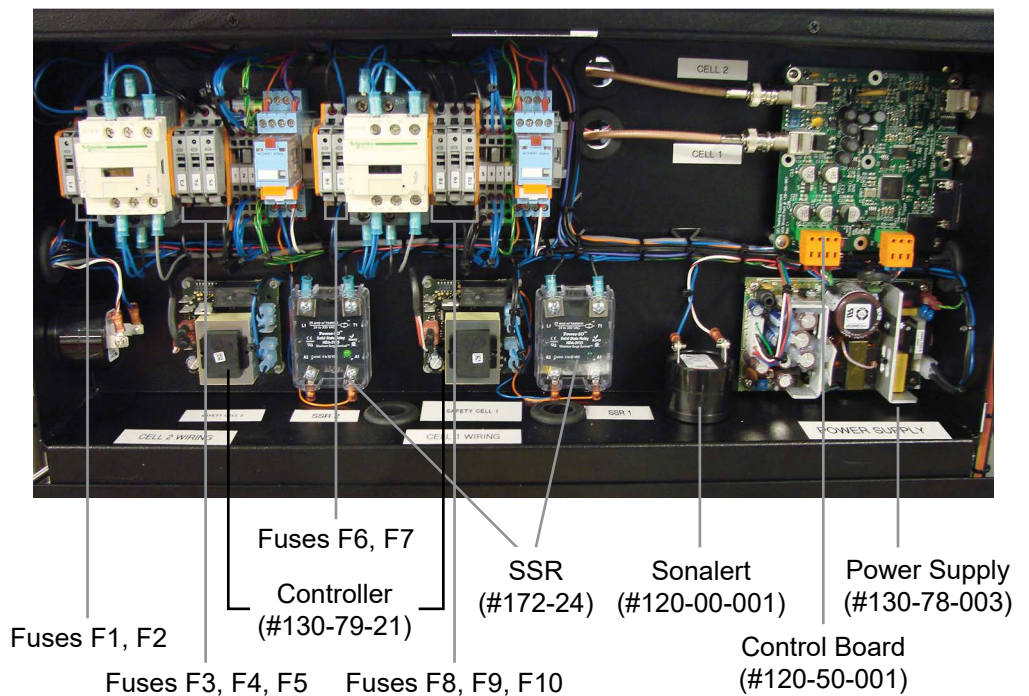

**Single Cell UCA (#120-50)
Top View With Middle Panel Removed**

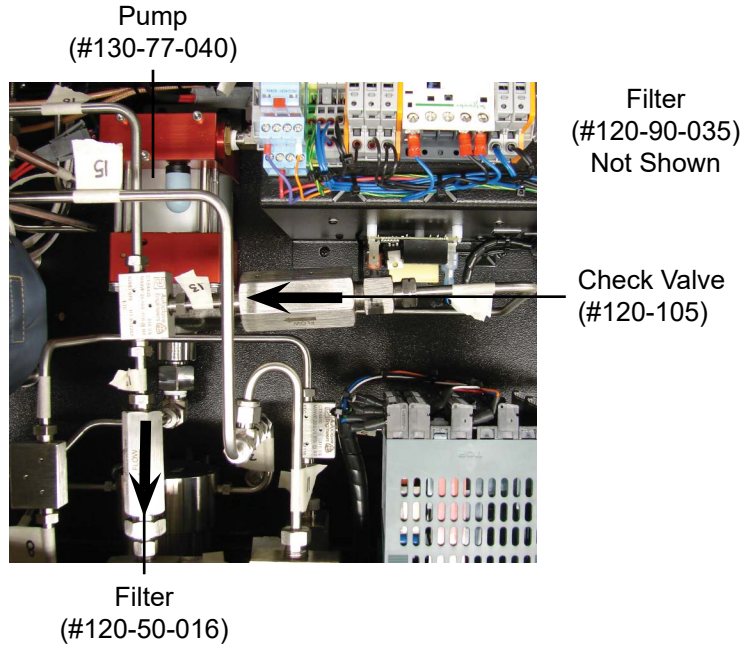

**Single Cell UCA (#120-50)
Electronics - Rear Panel Removed**

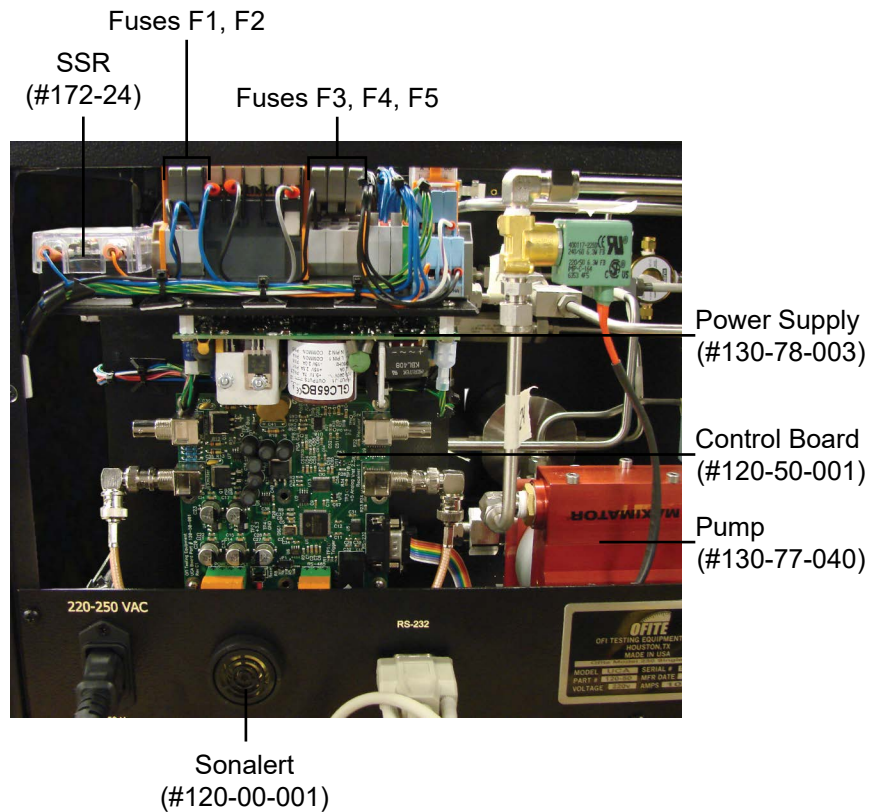

Appendix

Cell Diagram

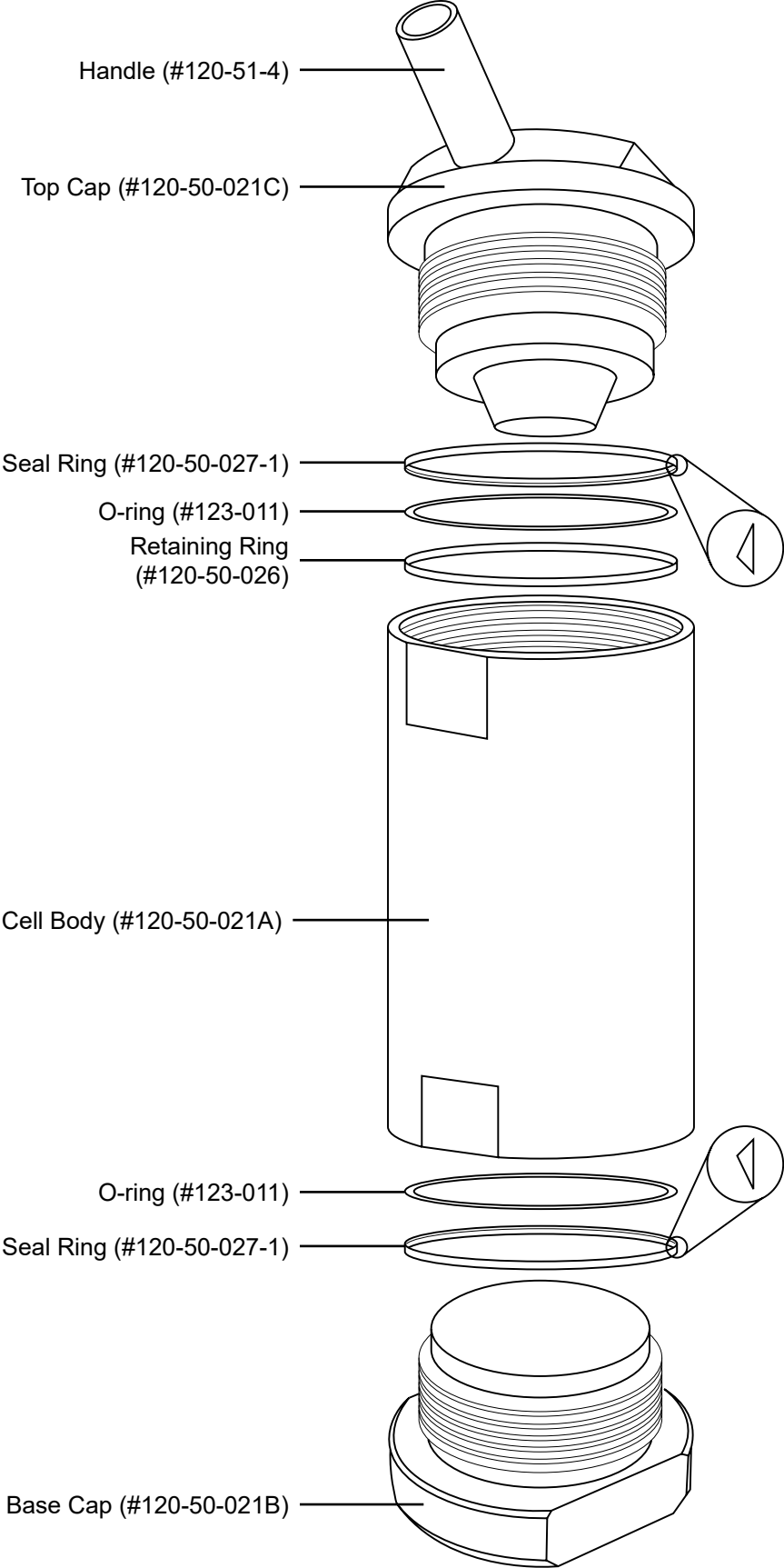

Warranty and Return Policy

Warranty:

OFI Testing Equipment, Inc. (OFITE) warrants that the products shall be free from liens and defects in title, and shall conform in all respects to the terms of the sales order and the specifications applicable to the products. All products shall be furnished subject to OFITE's standard manufacturing variations and practices. Unless the warranty period is otherwise extended in writing, the following warranty shall apply: if, at any time prior to twelve (12) months from the date of invoice, the products, or any part thereof, do not conform to these warranties or to the specifications applicable thereto, and OFITE is so notified in writing upon discovery, OFITE shall promptly repair or replace the defective products. Notwithstanding the foregoing, OFITE's warranty obligations shall not extend to any use by the buyer of the products in conditions more severe than OFITE's recommendations, nor to any defects which were visually observable by the buyer but which are not promptly brought to OFITE's attention.

In the event that the buyer has purchased installation and commissioning services on applicable products, the above warranty shall extend for an additional period of twelve (12) months from the date of the original warranty expiration for such products.

In the event that OFITE is requested to provide customized research and development for the buyer, OFITE shall use its best efforts but makes no guarantees to the buyer that any products will be provided.

OFITE makes no other warranties or guarantees to the buyer, either express or implied, and the warranties provided in this clause shall be exclusive of any other warranties including ANY IMPLIED OR STATUTORY WARRANTIES OF FITNESS FOR PURPOSE, MERCHANTABILITY, AND OTHER STATUTORY REMEDIES WHICH ARE WAIVED.

This limited warranty does not cover any losses or damages that occur as a result of:

- Improper installation or maintenance of the products
- Misuse
- Neglect
- Adjustment by non-authorized sources
- Improper environment
- Excessive or inadequate heating or air conditioning or electrical power failures, surges, or other irregularities
- Equipment, products, or material not manufactured by OFITE
- Firmware or hardware that have been modified or altered by a third party
- Consumable parts (bearings, accessories, etc.)

Returns and Repairs:

Items being returned must be carefully packaged to prevent damage in shipment and insured against possible damage or loss. OFITE will not be responsible for equipment damaged due to insufficient packaging.

Any non-defective items returned to OFITE within ninety (90) days of invoice are subject to a 15% restocking fee. Items returned must be received by OFITE in original condition for it to be accepted. Reagents and special order items will not be accepted for return or refund.

OFITE employs experienced personnel to service and repair equipment manufactured by us, as well as other companies. To help expedite the repair process, please include a repair form with all equipment sent to OFITE for repair. Be sure to include your name, company name, phone number, email address, detailed description of work to be done, purchase order number, and a shipping address for returning the equipment. All repairs performed as "repair as needed" are subject to the ninety (90) day limited warranty. All "Certified Repairs" are subject to the twelve (12) month limited warranty.

Returns and potential warranty repairs require a Return Material Authorization (RMA) number. An RMA form is available from your sales or service representative.

Please ship all equipment (with the RMA number for returns or warranty repairs) to the following address:

OFI Testing Equipment, Inc.
Attn: Repair Department
11302 Steeplecrest Dr.
Houston, TX 77065
USA

OFITE also offers competitive service contracts for repairing and/or maintaining your lab equipment, including equipment from other manufacturers. For more information about our technical support and repair services, please contact techservice@ofite.com.