



Dependable Products From People You Trust



Gas Migration Tester

#120-57 - 115 Volt
#120-57-1 - 230 Volt

Instruction Manual

Updated 6/14/2022
Ver. 4

OFI Testing Equipment, Inc.
11302 Steeplecrest Dr. · Houston, Texas · 77065 · U.S.A.
Tele: 832.320.7300 · Fax: 713.880.9886 · www.ofite.com

Table of Contents

Introduction	2
Description	2
Specifications	3
Components	4
Installation	6
Setup	7
Software	9
<i>Setup</i>	9
<i>Operation</i>	10
<i>Calibration</i>	11
Assembly	14
<i>Setup</i>	14
<i>Test Cell</i>	15
<i>Installing the Test Cell</i>	20
Testing	22
<i>Starting the Test</i>	22
<i>Completing the Test</i>	23
<i>Removing Cement from the Cell</i>	26
<i>Cell Diagram</i>	27
Warranty and Return Policy	28

Introduction

The problems of gas migration after cementing operations have been well documented. The costs associated with these problems, as well as stricter environmental regulations, have forced gas well operators to look for methods to minimize gas migration.

The OFITE Gas Migration Tester helps predict and overcome the potential for gas migration after cementing. This unit evaluates both the potential and severity of gas migration at downhole conditions with the recommended slurry. This allows for the design of the most economical and reliable cement slurry for a particular well.

Description

A test cell is filled with a cement slurry and placed into a heating jacket. The test cell is fitted with a piston above the slurry and a screen below. A back pressure regulator below the test cell applies back flow pressure. Hydrostatic pressure is applied to the piston and nitrogen/gas pressure is applied through the piston tubing and onto the cement slurry. As the slurry hardens, if the cement is sufficiently permeable, the nitrogen pressure will force the gas through the back pressure regulator to be collected and measured. Both filtrate and gas volume are collected.

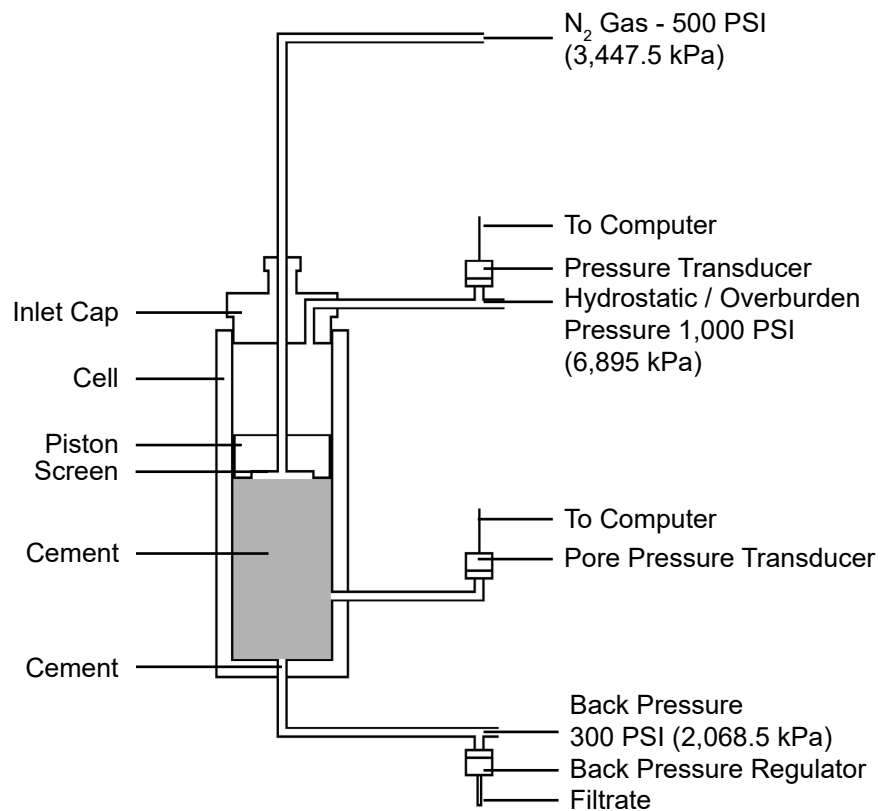

Specifications

- Maximum Temperature: 400°F (204.4°C)
- Maximum Pressure: 2,000 PSI (13,790 kPa)
- Crated Size: 43" × 36" × 48" inches (109.2 × 91.4 × 121.9 cm)
- Crated Weight: 469 lb (212.7 kg)
- Voltage: 115 / 220 Volts
- Requires 1,000 PSI (6,895 kPa) Nitrogen Supply

Components

#120-57-07	Pressure Sensor, 0 - 2,500 PSI (0 - 17,350 kPa)
#130-76-03	Thermocouple, Qty: 2
#153-67	Syringe, Disposable, 60 cc, Qty: 4
#154-63	Spatula, Micro Spoon, 9" Flat Handle
#165-14-8	Thermocouple, Type "J", 1/8" x 6"
#170-17	O-ring for Valve Stem
#170-18	Removable Cement Screen, 325 Mesh with 60 Mesh Backup

Optional:

#120-57-SP	Spare Parts for #120-57:
#120-57-01	Screen, 325 Mesh, Qty: 20
#120-57-02	Screen, 60 Mesh, Qty: 10
#120-57-03	Piston Seal, Qty: 6
#120-57-04	O-ring for Screen, Qty: 6
#120-57-05	Rod Seal, Qty: 6
#120-57-06	Packing Grease, Qty: 3
#153-67	Syringe, Disposable, 60 cc, Qty: 6
#170-13-3	O-ring for Test Cell, Viton, Qty: 24
#170-17	Valve Stem O-ring, Qty: 12
#170-18	Removable Cement Screen, 325 Mesh with 60 Mesh Backup, Qty: 6
#171-90-09	Valve Stem, Filtrate Outlet, Qty: 2
#120-57-21	Knock Out Tool
#120-910-057-RK	Repair Kit for Back Pressure Regulator

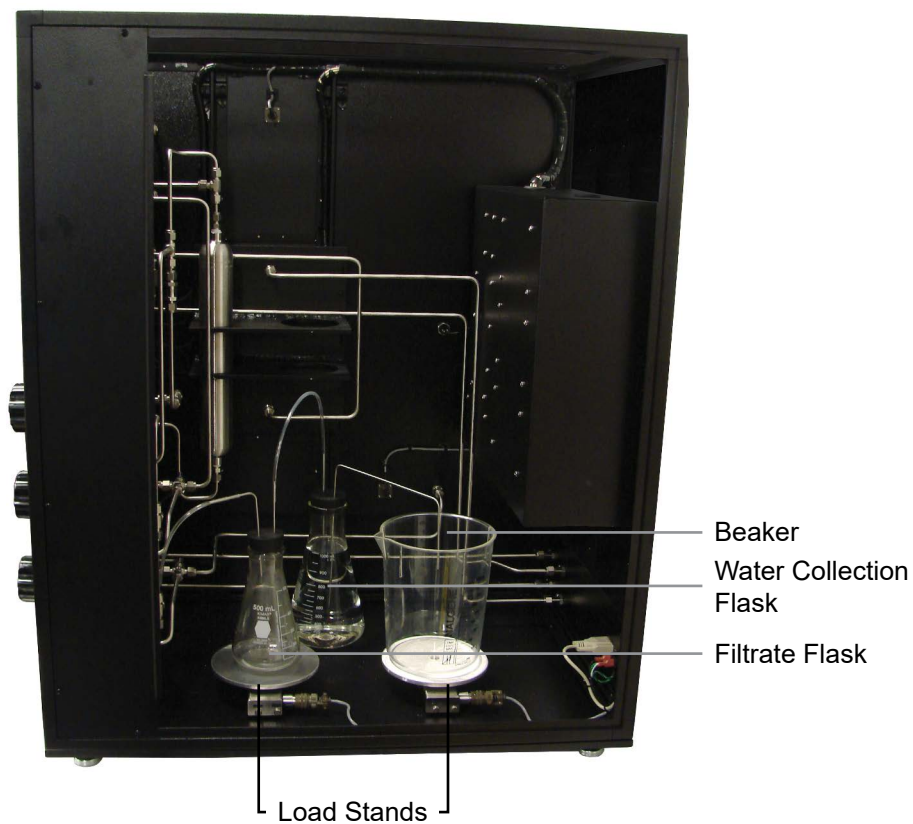
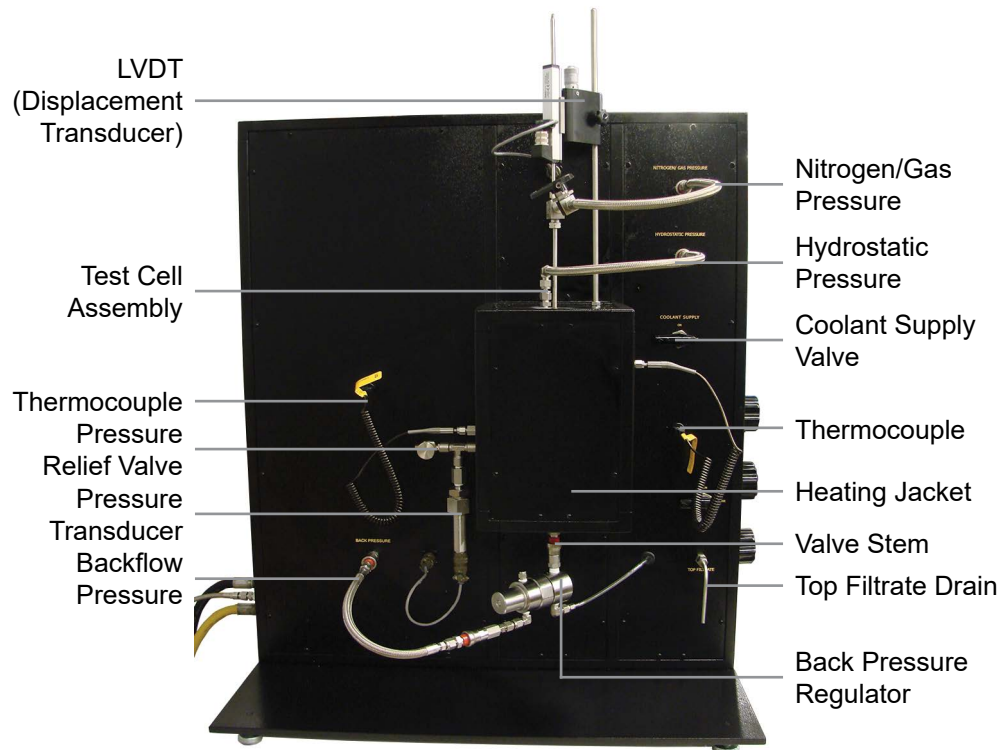

Installation

1. Carefully remove the unit from the packing crate and place it on a stable counter top or table.
2. Plug the AC power cord into an appropriate outlet.
3. Connect a nitrogen air supply (at least 1,000 PSI) to the back of the unit via the top ¼" female NPT port.
4. The Coolant In and Coolant Out ports on the back connect to plumbing that circulates around the heating jacket. The cell can be cooled with either tap water or a chiller. Both ports are ¼" NPT.
5. Connect the PC to the unit with a serial cable.
6. Turn the "Main Power" switch on.

Setup

Before beginning a test, the cement slurry should be fully conditioned according to API specifications. While the cement is conditioning, begin preparing the equipment for the test. The test should begin no more than five minutes after the cement is conditioned.

1. Make sure all valves on the unit are closed.
2. Make sure all three regulators are closed by turning them fully counter-clockwise.
3. Turn on the “Main Power” switch and wait for the PC to boot.
4. Connect the back pressure regulator to the “Backflow Pressure” port on the unit cabinet via the quick-connect hose.
5. Feed the plastic tubing from the back pressure regulator through the hole in the enclosure. Connect the plastic hose to the small rubber stopper (250 mL). Connect the second hose from small rubber stopper to the first port on the big rubber stopper (1000 mL).

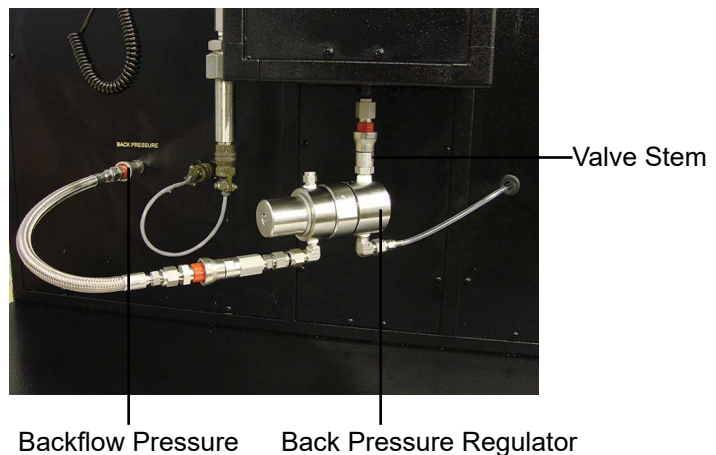

6. Securely tighten the small rubber stopper to the 250 mL volumetric flask.

The unit will not function if the small rubber stopper is not secure.

7. Fill the second flask with 1,000 mL water and insert the second rubber stopper. Connect another rubber tube from the filtrate flask to the water collection flask and set the water collection flask next to the load stands.
8. Fill the second flask with 1000 mL water. Install the big rubber stopper on the 1000 mL flask. Make sure it is tight and secure.

Make sure the inlet port on the stainless steel tubing is below the level of the water. The beaker will collect discharge water from the stainless steel tubing.



Note

- Place the overflow from the water collection flask into the beaker and set the beaker on the right load stand.

Make sure the rubber stoppers form a tight seal.

This setup allows the unit to automatically measure the filtrate and gas volume collected during the test. Both the filtrate and the nitrogen gas will be captured by the back pressure receiver. From there, it is emptied into the filtrate flask. The filtrate will then be weighed by the load stand, while the gas will be pushed into the water collection flask. In the water collection flask, the gas displaces the water and pushes it into the beaker where it is weighed by the load stand.

Since the density of water is 1 g/mL, the weight (in grams) of the displaced water corresponds to the volume of nitrogen gas that has migrated through the cement.

- Return to the computer screen and wait for the “Filtrate Volume” and “Gas Volume” values to stabilize. Zero both of these values.

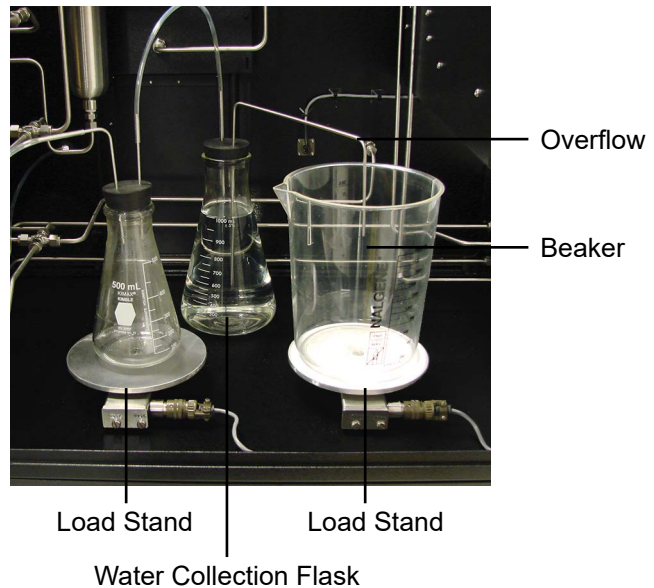

Software

Setup

1. Open the software by double-clicking the icon on the desktop.
2. From the “Utilities” menu choose “Setup”.

DAQ Time: Determines how often the data file is updated.

Pressure Unit: Choose either PSI or MPa.

Temp Unit: Choose either Deg F or Deg C.

Distance Unit: Choose either Millimeter or Inches.

Archive Path: The location of the data file.

Print to Printer: At the end of the test, the software will automatically generate an image file of the graph. If the “Print to Printer” box is checked, this graph will automatically be printed to the default printer.

3. Click “OK” to save changes.

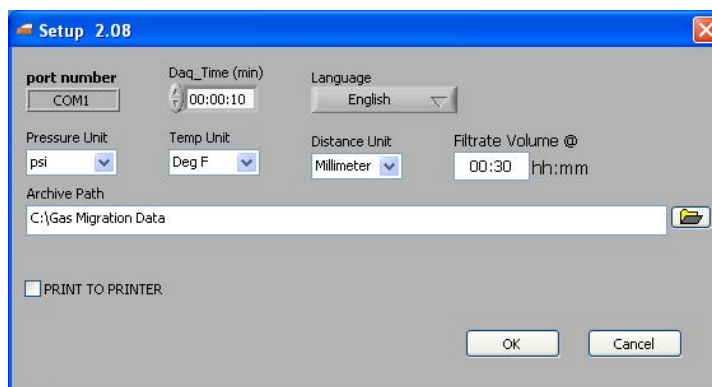

Software Operation

Before starting the test, it is important to prepare the software for testing.

1. Open the software by double-clicking the icon on the desktop.



2. From the “Utilities” menu, select “Load Sample Infos”. Give the test a name. The name will print on the graph at the end of the test. The rest of the fields on this screen are optional and are for display only.
3. Click “OK” to save the changes.

Software

Calibration

1. From the “Edit” menu, choose “Calibration”. The following fields make up the calibration screen:

Variable:	Selects which device is being calibrated.
Value Low:	The low value in the calibration
Value Hi:	The high value in the calibration
Sig. Lo:	The signal value corresponding to Value Low .
Sig. Hi:	The signal value corresponding to Value Hi .
Raw Value:	The value currently being sent by the equipment.
Low (Button):	Copies the Raw Value into the Sig. Lo . field.
High (Button):	Copies the Raw Value into the Sig. Hi . field.
Store Cal:	Stores the calibration values in memory.

The screenshot shows a calibration screen with the following elements:

- Variable:** A dropdown menu currently showing "Sample Temp." with a green highlight.
- Value Low:** A text input field containing "0".
- Value Hi:** A text input field containing "200".
- Raw Value:** A text input field containing "200".
- Sig. Lo.:** A text input field containing "0".
- Sig. Hi.:** A text input field containing "200".
- Low (Button):** A blue button with a right-pointing arrow.
- High (Button):** A blue button with a right-pointing arrow.
- Store Cal:** A red button with a right-pointing arrow.
- Exit Cal.:** A grey button.

2. Choose the device to be calibrated from the “Variable” drop-down list.
 - a. **Sample Temp** and **Cell Temp**
 - i. Before calibrating either temperature, set the temperature units to °C. Refer to page 2 for instructions.
 - ii. Insert the thermocouple into a calibrating block. Make sure the thermocouple is plugged into the appropriate port.
 - iii. Set the calibrating block to 0°C. Refer to the documentation provided with the calibrating block for instructions.
 - iv. Enter the reading from the calibrating block into the **Value Low** field. Once the **Raw Value** has stabilized, click the “Low” button.
 - v. Set the calibrating block to 200°C.
 - vi. Enter the reading from the calibrating block into the **Value Hi** field. Once the **Raw Value** has stabilized, click the “High” button.
 - vii. Click the “Store Cal” button to save the calibration data.

b. Filtrate Volume and Gas Volume

- i. Remove all weight from the specified load balance inside the machine. The Filtrate Volume is measured on the left-hand side and the Gas Volume is measured on the right-hand side.
- ii. Enter 0 in the **Value Low** field. Once the **Raw Value** has stabilized, click the “Low” button.
- iii. Now place a 500g weight on the load balance.
- iv. Enter 500 in the **Value Hi** field. Once the **Raw Value** has stabilized, click the “High” button.
- v. Click the “Store Cal” button to save the calibration data.

c. Piston Location

- i. Before calibrating the piston location, set the Distance Units to mm. Refer to page 9 for instructions.
- ii. Turn the LVDT so that the transducer rod is touching the heating jacket.
- iii. Lower the LVDT all the way down.
- iv. Enter 0 in the **Value Low** field. Once the **Raw Value** has stabilized, click the “Low” button.
- v. Now raise the LVDT up 50 mm.
- vi. Enter 50 in the **Value Hi** field. Once the **Raw Value** has stabilized, click the “High” button.
- vii. Click the “Store Cal” button to save the calibration data.

d. Back Pressure, Over Pressure, and Nitrogen Pressure

- i. Release all pressure from the system.
- ii. Enter 0 in the **Value Low** field. Once the **Raw Value** has stabilized, click the “Low” button.
- iii. Connect a calibrated gauge to the appropriate pressure outlet on the unit case. For calibrating Over Pressure, connect the gauge to the “Hydrostatic Pressure” outlet.

- iv. Increase the appropriate pressure. For calibrating the Nitrogen Pressure, increase the pressure to 1,000 PSI. For calibrating the Back Pressure, increase the pressure to 400 PSI. For calibrating the Over Pressure, increase the pressure to 550 PSI.
- v. Enter the reading from the calibrated gauge into the **Value Hi** field. Once the **Raw Value** has stabilized, click the “High” button.
- vi. Click the “Store Cal” button to save the calibration data.

e. **Pore Pressure**

- i. Release all pressure from the system.
- ii. Enter 0 in the **Value Low** field. Once the **Raw Value** has stabilized, click the “Low” button.
- iii. Assemble the test cell with water instead of cement.
- iv. Connect a calibrated gauge to the Relief Valve near the pressure transducer.
- v. Open the Pressure Relief Valve.
- vi. Increase the Nitrogen Pressure to 1,000 PSI.
- vii. Enter the reading from the calibrated gauge into the **Value Hi** field. Once the **Raw Value** has stabilized, click the “High” button.
- viii. Click the “Store Cal” button to save the calibration data.

Assembly Setup

Before assembling the test cell, make sure the fixtures on the side are adequately greased. This will prevent cement slurry from hardening inside the fixtures and damaging the parts.

1. Unscrew the transducer assembly and completely fill the space inside with high-temperature grease. Replace the transducer, then open the relief valve and fill the remaining space. Close the relief valve.
2. Remove the thermocouple and inject the grease directly into the fixture.
3. Replace the thermocouple.



Tip

To verify that enough grease has been used, look into the cell and observe the two holes on the side. You should be able to see grease overflowing the two fixtures into the test cell. Wipe any excess grease from the inside of the cell.

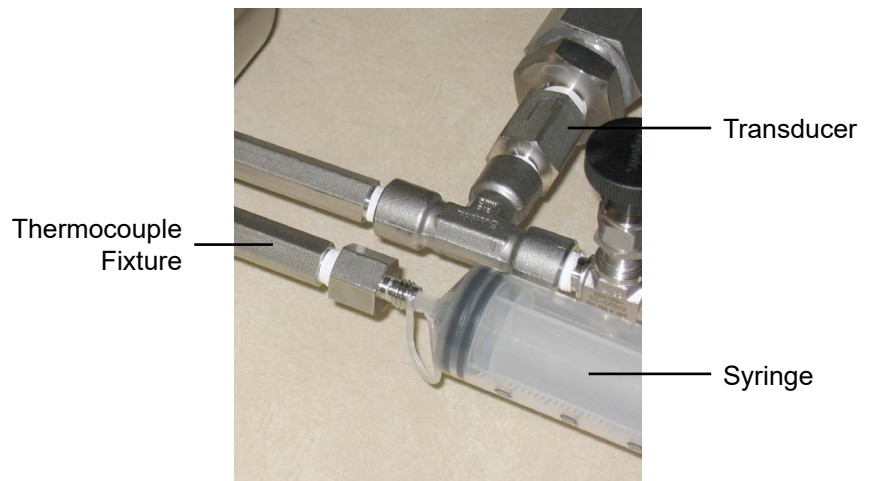
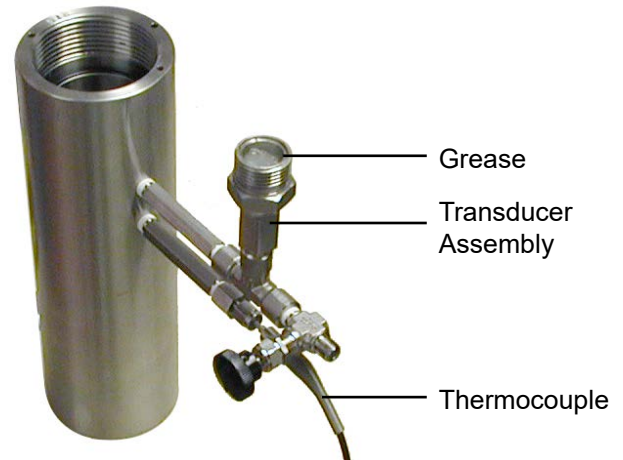

Assembly

Test Cell

During the assembly process, be sure to coat all o-rings and seal rings (any part made of rubber) with grease. This will make it easier to remove the cement slurry when the test is complete.

1. Assemble the piston head.
 - a. Insert an o-ring into the o-ring groove in the bottom of the Piston.
 - b. Place the screens inside the bottom of the piston, over the o-ring. The screen with the tighter mesh goes on the outside.
 - c. Screw the brass retainer ring in place, securing the screen and o-ring. Do not over tighten.

Piston Head

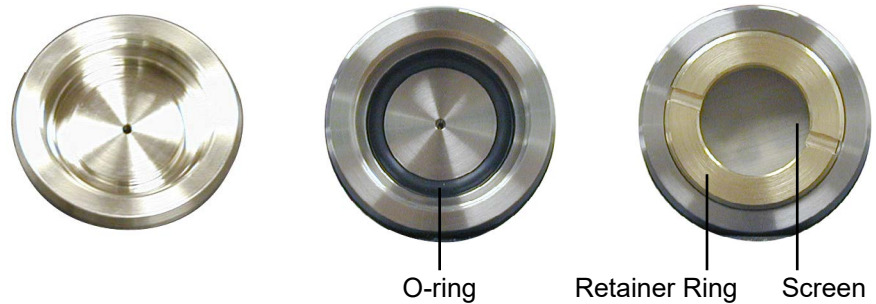

2. Assemble the inlet cap.
 - a. Place the rod seal into the hole in the bottom of the inlet cap. Be sure to press it all the way down inside the hole.
 - b. Screw the brass seal plug in place, securing the rod seal. Do not over tighten.
 - c. Place an o-ring in the groove around the bottom edge of the cap.

Inlet Cap



- Slide the inlet cap onto the piston rod. The threads on the piston rod can damage the seal plug. To avoid this, twist the inlet cap in a screwing motion until it is past the threads.
- Slide the top portion of the Autoclave F250C connector onto the piston rod above the inlet cap.
- Screw the bottom portion of the Autoclave F250C connector onto the threaded portion of the piston rod. Leave about 1/4" space between the connector and the end of the rod.

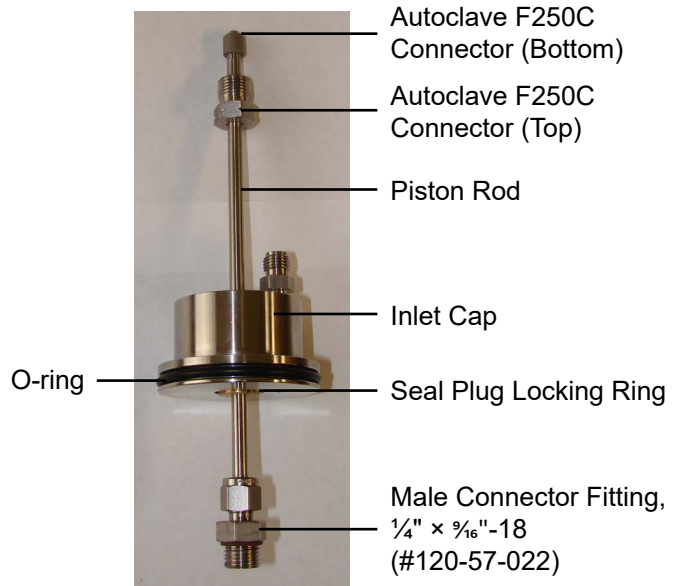

- Place an o-ring into the groove inside the spacer. Then place the spacer onto the piston rod with the o-ring facing the inlet cap. After the spacer, place the seal ring screw, o-ring, seal ring, and o-ring onto the piston rod. Refer to the photo below.

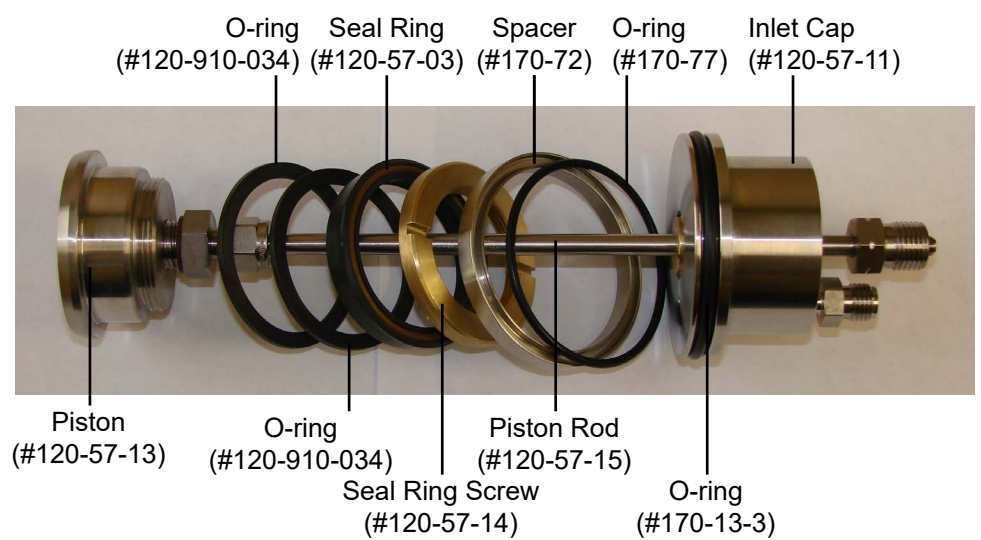

7. Screw the piston rod into the piston head.

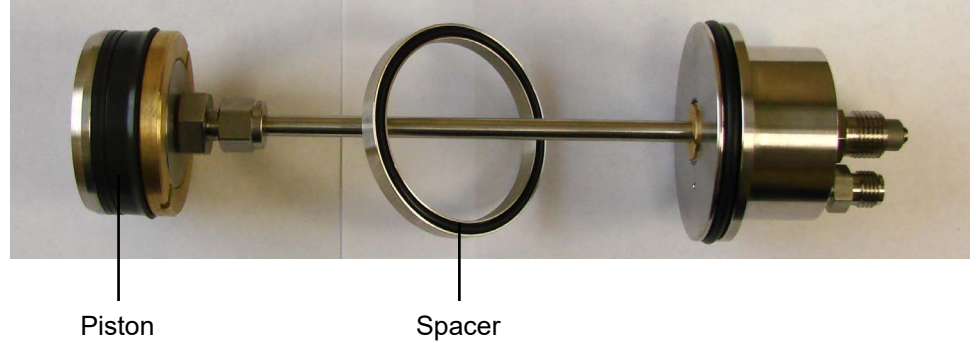

8. Slide the o-ring and seal ring onto the piston and secure them with the seal ring screw.
9. Place an o-ring into the groove inside the top of the test cell.
10. Press the spacer down around the top of the piston. Then slide the piston assembly into the top of the test cell. The spacer will stay at the top while the piston will continue to go down into the cell.



11. Push the piston, locking ring, and inlet cap down into the cell as far as possible. Place the locking ring around the inlet cap and screw it into place. Tighten the locking ring.

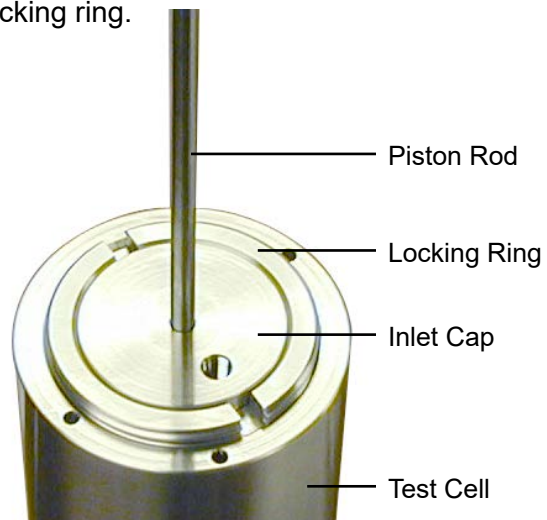

12. With the piston in place, carefully remove the locking ring and inlet cap so that you can fill the space with oil. Bring the inlet cap to the top of the piston rod and pour oil into the space covering the o-ring groove in the test cell. Bring the inlet cap back down and screw the locking ring into place. Oil should come out of the hydrostatic pressure port. Cap both the hydrostatic port on inlet cap and the nitrogen port on the piston rod to prevent oil from leaking out.
13. Turn the cell over and pour in the cement slurry. Fill the cell to within $\frac{1}{8}$ " of the o-ring groove. Refer to API Specification 10 for more information about preparing the slurry.



Be careful not to rest the weight of the cell on the valve stem. Instead, set the cell on the provided cell stand. This will protect the plumbing and provide a stable platform to support the cell. Keep the piston rod secure to prevent the piston connector from becoming loose.

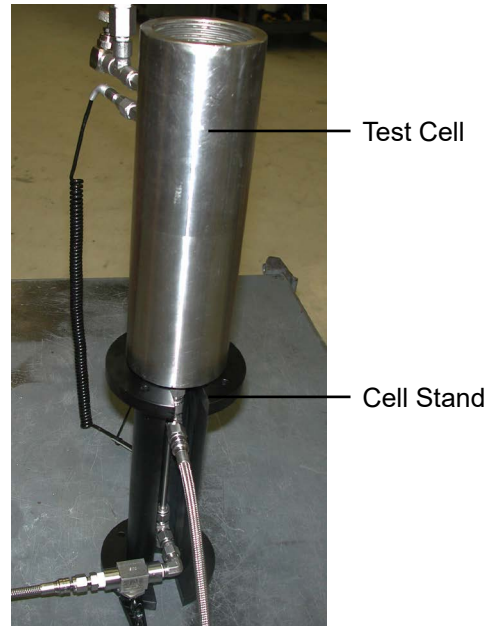

14. Place an o-ring into the groove inside the bottom of the test cell.
15. Place the screen on top of the o-ring with the flat side facing down.
16. Place another o-ring on top of the screen.
17. Screw the bottom cell cap into the cell and tighten completely.
18. Screw the valve stem into the hole in the bottom of the cell cap. Make sure the valve is closed by tightening it completely with a wrench.



Assembly

Installing the Test Cell

1. Carefully place the cell into the heating jacket. Make sure the valve stem protrudes through the hole in the bottom and that the fixtures on the side of the cell slide into the notch on the side of the heating jacket.
2. Plug the sample thermocouple and pressure transducer into the appropriate ports on the unit cabinet to the left of the heating jacket.

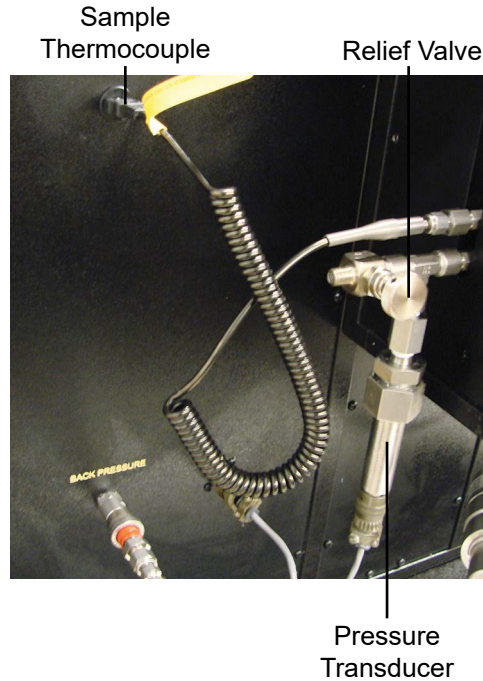

3. Connect the hydrostatic pressure inlet to the "Hydrostatic Pressure" port on the unit cabinet via a quick-connect hose.

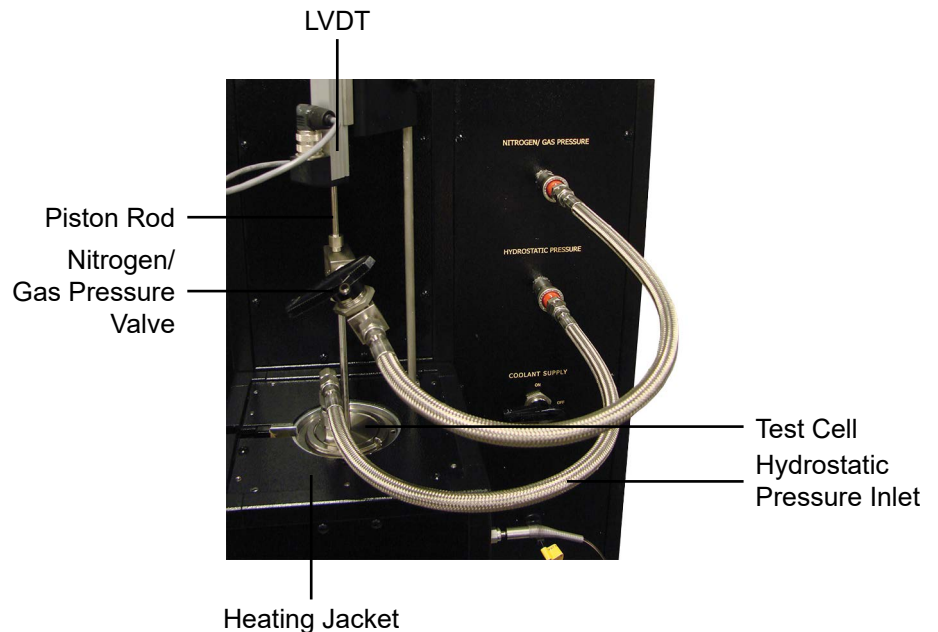

4. The valve that is attached to the piston rod should be connected to the “Nitrogen/Gas Pressure” port on the unit cabinet via a quick-connect hose.
5. Plug the cell thermocouple into the port on the cabinet to the right of the heating jacket. Insert the thermocouple into the hole on the top edge of the test cell.
6. Attach the back pressure regulator to the valve stem via the quick-connect port.
7. In order to get accurate readings from the load cell, it is necessary to fill the plastic tubing with water before beginning a test. Unscrew the plastic tube from the back pressure regulator outlet. Then inject water into the tubing with a syringe. Inject just enough to fill the tubing without pushing water into the flask on the other end.

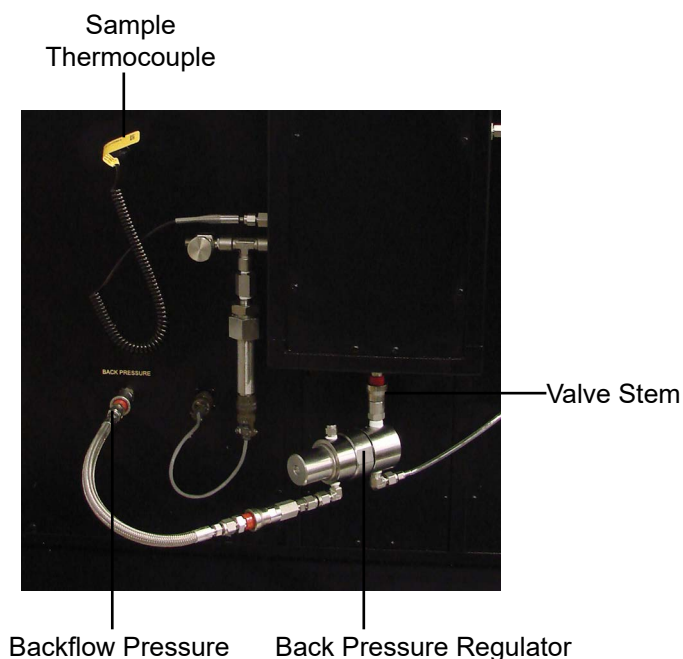

Testing

Starting the Test



Refer to the diagram on page 2 for a visual explanation of the test.

1. Open the Air Supply valve at the bottom of the control panel.
2. Once again, make sure the valve stem on the bottom of the test cell is closed.
3. Close the “Nitrogen/Gas Pressure Valve” (see picture on page 19) by turning the valve handle perpendicular to the hose it is attached to.
4. If your test requires a temperature setting above 180°F (82°C), pre-heat the cell to 180°F (82°C) before adding pressure. Then, when the pressure is set, increase the temperature to the desired level.

To set the temperature, go to the main software screen and enter a value in the “Temperature Setpoint” field. Then click the “Heat On” button to activate the heater. The “Heat Power” switch on the unit must be on. Before heating the cell, make sure the Cooling valve is closed.

If your test requires a temperature setting below ambient, set the temperature in the software to 0, turn on the chiller, and open the Cooling valve. The cell temperature must be controlled on the chiller, not the software.

5. Set the back flow pressure. (300 PSI recommended)
6. Next, Set the hydrostatic pressure. Slowly turn the regulator clockwise until the desired pressure is reached. (1,000 PSI recommended)

The hydrostatic pressure must always be at least 200 PSI above the Nitrogen pressure. Failure to do so could damage the equipment.



7. Finally, set the nitrogen pressure. (500 PSI recommended)
8. Turn the LVDT so that the transducer rod is sitting on top of the piston rod. Lower the LVDT unit until the transducer rod is all the way in the up position.
9. Once the LVDT is in position, tighten the locking screw. Then zero the software by clicking the “Zero Piston Distance”, “Zero Gas Volume”, and “Zero Filtrate Volume” buttons on the main software screen.
10. Click the “Start Test” button. Confirm that the test information is correct.
11. Open the “Nitrogen/Gas Pressure Valve”.
12. Slowly open the valve stem on the bottom of the test cell one quarterturn.
13. Once the test begins, the PC will begin to display data on the main software screen.

Testing

Completing the Test

1. Turn off the heater by clicking the “Heat Off” button in the software and turning the “Heat Power” switch off.
2. Click the “Stop Test” button.
3. For high temperature tests, open the Cooling valve. Wait for the cell to cool to 120°F (49°C).
4. Close the valve stem on the bottom of the test cell. Close the “Nitrogen/ Gas Pressure Valve”.
5. Slowly release the Nitrogen/Gas regulator valve.
6. Slowly release the Hydrostatic regulator valve.



The hydrostatic pressure must always be at least 200 PSI above the Nitrogen pressure. Failure to do so could damage the equipment.

Always release the pressure very slowly to avoid pulling cement into the plumbing.

7. Slowly release the Back Flow regulator valve.
8. Place a beaker or other suitable container underneath the Top Filtrate drain. Slowly open the Top Filtrate valve.
9. Slowly open all of the bleed valves on the right-hand side of the control panel and place the “Air Supply” valve in the “Bleed” position.
10. Slowly open the relief valve on the transducer port on the test cell. Refer to the photo on page 5.
11. Once all pressure has been released, disconnect all of the hoses and the back pressure regulator from the test cell. Remove the two thermocouples and unplug the pressure transducer. Then carefully remove the test cell from the heating jacket.



Make sure all pressure is relieved from the cell before attempting to remove it. If any of the valves or fittings are difficult to remove, the cell is still pressurized.

The test cell may still be very hot. Be sure to wear protective gear when handling the test cell.

12. Disassemble the test cell and thoroughly clean all of the parts with soap and water. Be sure to remove any remaining cement. Refer to page 26 for instruction for removing cement that is stuck in the cell.

13. The back pressure regulator may contain some residual debris that must be removed. To clean the device, apply pressure to force out any foreign material:
 - a. If the back pressure regulator is still connected to the test cell, disconnect it and remove the tube and quick-connect hose.
 - b. Connect the unit to the Back Flow Pressure via the quick-connect hose. Attach the hose to the same port that was previously connected to the valve stem on the test cell.
 - c. Close the Back Flow Pressure bleed valve on the right-hand side of the control panel.
 - d. Gradually increase the Back Flow Pressure until the entire contents of the back pressure regulator has been forced out.



Be sure to direct the flow of debris away from people and equipment.

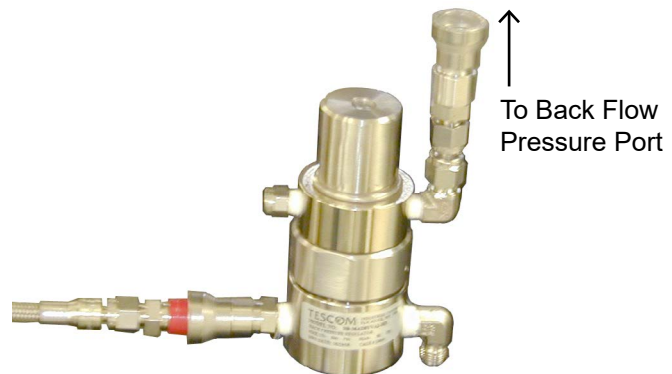

14. Remove the flasks, beaker, and tubing from the inside of the unit cabinet and thoroughly clean them with soap and water.

15. To recall data from a previous test, choose “Test Archive” from the “File” menu in the software.
16. Under Directories, choose the year and month of the test you want to open. For example, a test run in January of 2010 will be labeled as “2010 Month01”.
17. Under tests, choose the test you want to open. These are labeled by date, time, and test name.
18. When you click on a test, the software will show the test data and the graph. If you want to print the chart, click the “Print Chart” button.

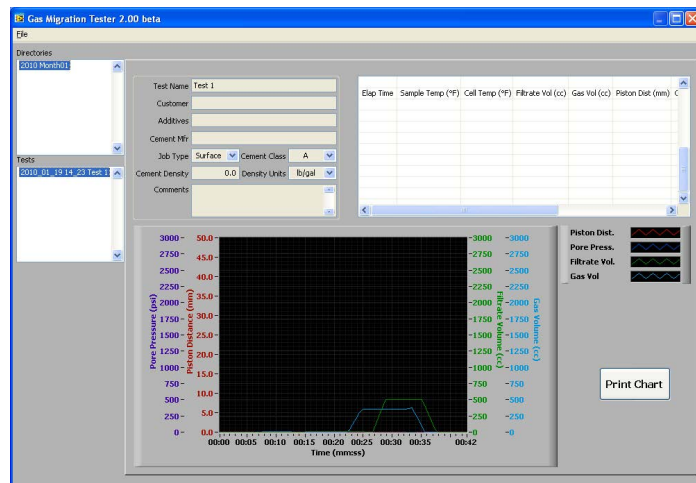

Appendix

Removing Cement from the Cell

If cement has cured inside the cell, it may be necessary to use force to remove it. The Knock Out Tool (#120-57-21) will help you safely extract the cement from the cell.

1. Remove all fittings and caps from the cell body.
2. Place the cell on the Knock Out Tool stand on a flat, stable surface.
3. Place the smallest piston inside the cell so that it sits on top of the cement. If the piston does not extend above the top of the cell, try the next longest piston.
4. Carefully hit the piston with a hammer.

The cement plug may fall out of the cell after a few hits from the hammer. If it doesn't continue hitting it until it has been pushed completely out of the cell.

5. If the top of the piston sinks below the opening of the cell, remove the piston and replace it with the next longest.

Be very careful not to hit the cell body with the hammer.

6. Repeat steps 4 and 5 until the cement is forced completely out of the test cell.

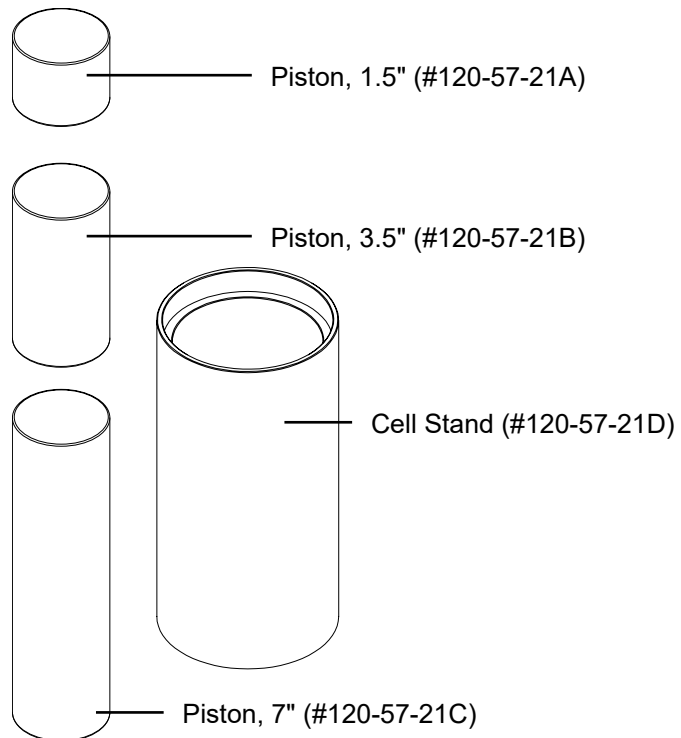

Appendix

Cell Diagram

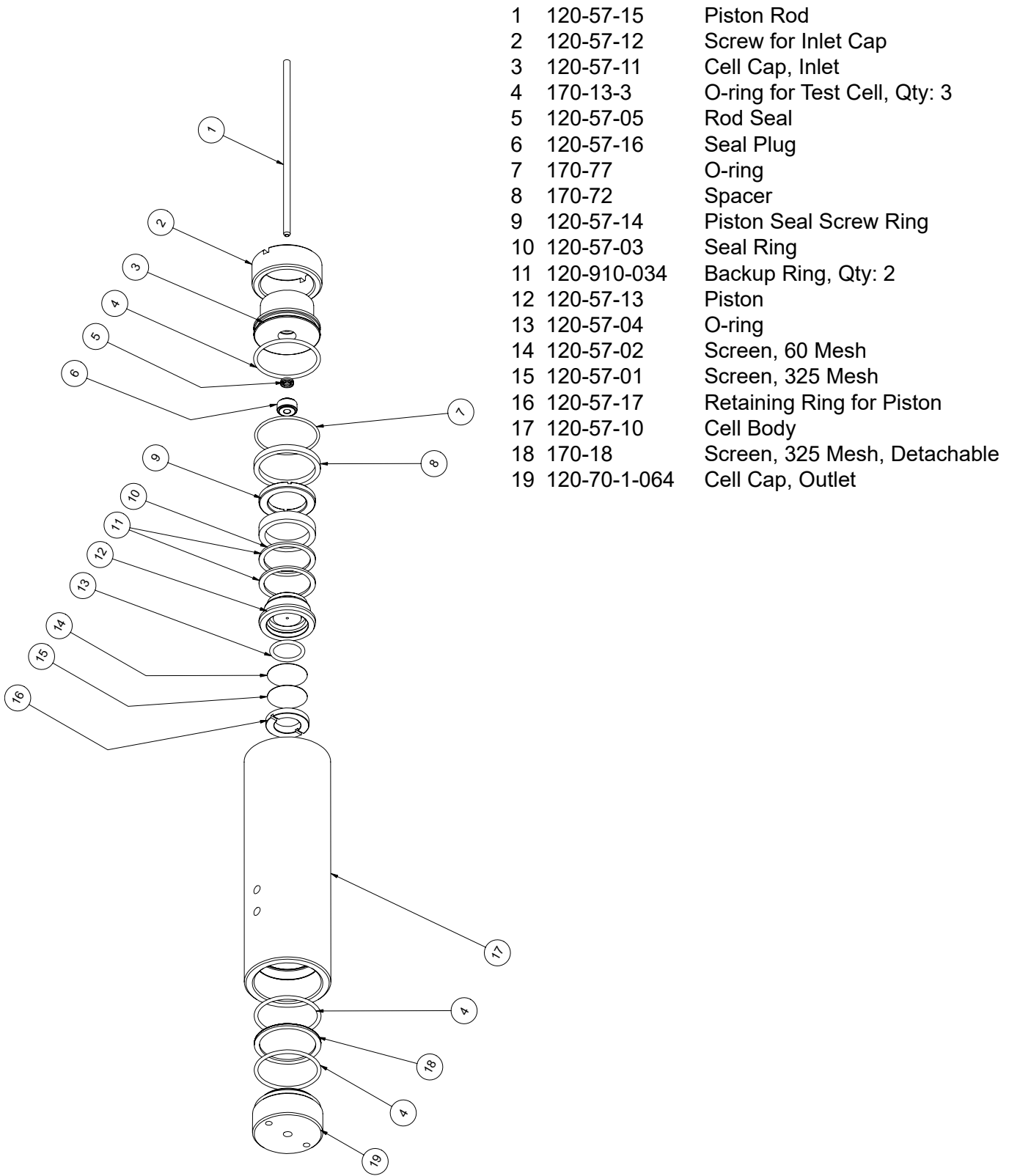

Warranty and Return Policy

Warranty:

OFI Testing Equipment, Inc. (OFITE) warrants that the products shall be free from liens and defects in title, and shall conform in all respects to the terms of the sales order and the specifications applicable to the products. All products shall be furnished subject to OFITE's standard manufacturing variations and practices. Unless the warranty period is otherwise extended in writing, the following warranty shall apply: if, at any time prior to twelve (12) months from the date of invoice, the products, or any part thereof, do not conform to these warranties or to the specifications applicable thereto, and OFITE is so notified in writing upon discovery, OFITE shall promptly repair or replace the defective products. Notwithstanding the foregoing, OFITE's warranty obligations shall not extend to any use by the buyer of the products in conditions more severe than OFITE's recommendations, nor to any defects which were visually observable by the buyer but which are not promptly brought to OFITE's attention.

In the event that the buyer has purchased installation and commissioning services on applicable products, the above warranty shall extend for an additional period of twelve (12) months from the date of the original warranty expiration for such products.

In the event that OFITE is requested to provide customized research and development for the buyer, OFITE shall use its best efforts but makes no guarantees to the buyer that any products will be provided.

OFITE makes no other warranties or guarantees to the buyer, either express or implied, and the warranties provided in this clause shall be exclusive of any other warranties including ANY IMPLIED OR STATUTORY WARRANTIES OF FITNESS FOR PURPOSE, MERCHANTABILITY, AND OTHER STATUTORY REMEDIES WHICH ARE WAIVED.

This limited warranty does not cover any losses or damages that occur as a result of:

- Improper installation or maintenance of the products
- Misuse
- Neglect
- Adjustment by non-authorized sources
- Improper environment
- Excessive or inadequate heating or air conditioning or electrical power failures, surges, or other irregularities
- Equipment, products, or material not manufactured by OFITE
- Firmware or hardware that have been modified or altered by a third party
- Consumable parts (bearings, accessories, etc.)

Returns and Repairs:

Items being returned must be carefully packaged to prevent damage in shipment and insured against possible damage or loss. OFITE will not be responsible for equipment damaged due to insufficient packaging.

Any non-defective items returned to OFITE within ninety (90) days of invoice are subject to a 15% restocking fee. Items returned must be received by OFITE in original condition for it to be accepted. Reagents and special order items will not be accepted for return or refund.

OFITE employs experienced personnel to service and repair equipment manufactured by us, as well as other companies. To help expedite the repair process, please include a repair form with all equipment sent to OFITE for repair. Be sure to include your name, company name, phone number, email address, detailed description of work to be done, purchase order number, and a shipping address for returning the equipment. All repairs performed as "repair as needed" are subject to the ninety (90) day limited warranty. All "Certified Repairs" are subject to the twelve (12) month limited warranty.

Returns and potential warranty repairs require a Return Material Authorization (RMA) number. An RMA form is available from your sales or service representative.

Please ship all equipment (with the RMA number for returns or warranty repairs) to the following address:

OFI Testing Equipment, Inc.
Attn: Repair Department
11302 Steeplecrest Dr.
Houston, TX 77065
USA

OFITE also offers competitive service contracts for repairing and/or maintaining your lab equipment, including equipment from other manufacturers. For more information about our technical support and repair services, please contact techservice@ofite.com.